

RAILTEL CORPORATION OF INDIA LIMITED
(A Govt of India Undertaking)

TENDER DOCUMENT FOR THE WORK OF:

**“SUPPLY & LAYING OF OFC, HDPE DUCT, POWER CABLE, ETC.
FOR PROVIDING WIFI SERVICES AT 10 NOS. RAILWAY STATIONS
OF CHANDIGARH TERRITORY OF NORTHERN REGION”**

(Tender No. RailTel/Tender/OT/RO/WiFi work/CDG/10 Stn/2015-16/23)

(Cost of Tender Document: Rs.5250/-, By post: Rs.5775/-)

Copy No:

Sold to: M/s -----

INDEX

SECTION – I		
CHAPTER	CONTENTS	PAGE NO.
	DETAILS OF TENDER NOTICE	3
	CHECK LIST TO ENSURE VALIDITY OF OFFER	4
1	OFFER LETTER (FORM-1)	5
2	PREAMBLE	7
3 PART- I	INSTRUCTION TO TENDERER & CONDITIONS OF TENDERING	10
3 PART- II	GENERAL CONDITIONS OF CONTRACT (GCC)	27
4	SPECIAL CONDITIONS OF CONTRACT (SCC)	57
5	BID DATA SHEET (BDS)	80
6	FORMS OF TENDER	84
7	SCHEDULE OF REQUIREMENTS (SOR)	102

SECTION – II		
CHAPTER	CONTENTS	PAGE NO.
1	PRECAUTIONS TO BE TAKEN IN 25 KV A.C. TRACTION AREA	107
2	PREPARATION OF AS-BUILT ROUTE PLANS	108
3	TECHNICAL SPECIFICATION & INSTRUCTIONS FOR OFC	112
4	SPECIFICATION FOR JOINTING AND TERMINATION OF OFC	122
5	TECHNICAL SPECIFICATIONS FOR EARTHING ARRANGEMENT	130
5	JOINTING OF 6 QUAD TELECOM CABLE & ACCEPTENCE TEST	131
6	LIST OF ADDRESS FOR SPECIFICATIONS	137

SECTION-III		
CHAPTER	CONTENTS	PAGE NO.
1	DRAWINGS	138-151
	LIST OF STATIONS	152

RailTel Corporation of India Limited
(A Govt of India Enterprise)
Regional Office: 6th floor, Block-III, Delhi IT Park,
Shastri Park, Delhi-110 053

OPEN TENDER NOTICE

Tender No. RailTel/Tender/OT/RO/WiFi work/CDG/10 Stn/2015-16/23

Dated: 20.02.2016

Regional General Manager , RailTel Corporation of India Limited, Northern Region , Delhi, invites the sealed Open Tenders in “single packet” system from established contractors with proven experience for the work of “**Supply & Laying of OFC, HDPE Duct, Power Cable, etc. for providing WiFi Services at 10 Nos. Railway Stations of Chandigarh Territory of Northern Region**”

Sale of Tender Document	From 20.04.2016 to 10.05.2016 (From 11:00 Hrs to 17:00 Hrs)
Last date & time of submission of tender:	Up to 15:00 hrs on 11.05.2016
Date & time of opening of tender:	At 15:30 hrs on 11.05.2016 (If the date of opening happens to be a holiday the tender will be opened on next working day at same time.)
Approximate cost:	Rs. 94,77,039/-
Earnest money:	Rs. 1,90,000/-
Completion period:	180 days from the date of issue of LOA
Validity of offer:	90 days from the date of opening of tender.
Cost of Tender Document:	Rs. 5,250/- (Five Thousand Two Hundred Fifty only) (incl. VAT @5%) and Rs. 5,775/-(Five Thousand Seven Hundred Seventy Five only) (incl. VAT @5%), if required by post
Note:	Tender Document may be obtained between 11:00 hrs to 17:00 hrs from 20.04.2016 to 10.05.2016 from the office of Executive Director, Northern Region, Delhi by paying the cost of tender document through Bank Draft in favour of “RailTel Corporation of India Limited” payable at Delhi. RCIL shall not be responsible for late receipt of tender documents for any postal delay, if required by post.

Tender Notice and Tender Document are also available on RailTel’s website and can be downloaded from www.railtelindia.com. The cost of Tender document shall, however, have to be deposited along with tender bid in the form of Demand Draft as detailed above.

GM/Project
For Regional General Manager/Northern Region

CHECK LIST (FOR ENSURING VALIDITY OF OFFER):

S.N	Description	Yes/No
1	Purchase of Tender Document	
2	Offer Letter Complete (Form no-1) duly signed	
3	Submission of Earnest Money in prescribed Form	
4	Audited balance sheet duly attested by Notary public for last Three year.	
5.	Proposed Progress Chart (Form No-7)	
6	Constitution of Firm and Power of Attorney.	
7	Similar Works executed or under execution .(form No.8).	
8	User certificate (Form no-9).	
9	System Performance Guarantee.(Form No-10)	
10	Schedule of Requirements duly filled and signed	
11	Any Other Information desired to be submitted by the Tenderer	
12	List of Personnels / Manpower	
13	List of Plant & Machinery	

SIGNATURE OF TENDERER
(WITH RUBER STAMP)

Form No. 1

OFFER LETTER

To
The Regional General Manager, Northern Region,
RailTel Corporation of India Limited,
6th floor, Block-III, Delhi IT Park
Shastri Park, Delhi-110 053

I/We _____ have read the various conditions detailed in tender documents attached here to and hereby agree to ABIDE BY THE SAID CONDITIONS. I/We also agree to keep this tender open for acceptance for a period of 30 days from the date fixed for opening the same and in default thereof, I/We will be liable for forfeiture of my/our Earnest Money. I/We offer to do the work of **“Supply & Laying of OFC, HDPE Duct, Power Cable, etc. for providing WiFi Services at 10 Nos. Railway Stations of Chandigarh Territory of Northern Region”** at the rates quoted in the attached schedules and hereby bind myself/ourselves to complete the work within **180 days** from the date of issue of Letter of Acceptance of the tender. I/We also hereby agree to abide by the various Conditions of Contract and to carry out the work according to the Specifications for materials and works laid down by the RailTel for the present contract.

2. A sum of Rs. 1,90,000/- (Rupees One Lac Ninety Thousand only) as a Account Payee Demand Draft No. _____ dated _____ issued by _____ is herewith forwarded as “Earnest Money”. The full value of Earnest Money shall stand forfeited without prejudice to any other rights or remedies if,

I/We do not execute the contract agreement within 15 days after receipt of notice issued by the RailTel that such documents are ready or,

I/We do not commence the work within 15 days after receipt of orders to that effect.

Until a formal agreement is prepared and executed the acceptance of this tender shall constitute a binding contract between us subject to modifications, as may be mutually agreed to between us and indicated in the “Letter of Acceptance” of my/our offer for this work.

SIGNATURE OF CONTRACTOR (S)

Date

SIGNATURE OF WITNESS

CONTRACTOR (S) ADDRESS

- 1.
- 2.

ACCEPTENCE OF TENDERS

I accept the tender as above and agree to pay the rate as entered in Schedule of Requirements.

WITNESS

For and on behalf of

RailTel Corporation of India Limited,
Northern Region, Delhi-110053
Date



SECTION - I

Chapter – 2

PREAMBLE

1. Name of work:

The name of the work as mentioned in Tender Notice is also indicated in Bid Data Sheet (BDS) Chapter 5 Section I.

2. Scope of work:

2.1 The broad responsibility of the contractor under the scope of work for this tender shall be as under:

- i) Excavation of trenches and laying of HDPE Duct in all types of soils, Road/Rail crossing, in building, clamping etc. & protective works as per technical specifications.
- ii) Back filling and dressing of the excavated trenches according to technical specifications.
- iii) Blowing/pulling of Optical Fiber Cable (24F/6F) with proper tools and accessories as per Technical specifications.
- iv) Installation of Jointing Chambers & Route/Joint Indicators as per technical specification.
- v) Splicing of fibres in Joint closures/FMS and installation of new joint enclosures/FMS.
- vi) Laying of power cables, Ethernet cables in DUCT, PVC conduit.
- vii) Installation of 6/9U rack & UPS at suitable height on platforms with all sorts of angle, nuts etc.
- viii) End to end testing & submission of test results, route diagrams.

2.2 Supply

Supply of items conforming to industry standards and RDSO specifications (where ever applicable) as per Schedule of Requirements and the technical specifications.

2.3 Services

Trenching, Laying, Splicing, Termination, Testing and Commissioning of Optical Fibre Cable as per schedule of Requirements (SOR) enclosed and technical specifications with other related service items.

2.4 List of Section/s where work for RailTel is to be done:

The details of the section/s where the work for RailTel is required to be done are indicated in Bid Data Sheet (BDS) Chapter 5 Section I.

3. Pre-bid conference

Not Used

4. Tender Bid

The tender bid shall be submitted in Single sealed covers as detailed in **Instructions to Tenderers and Condition of Tendering (ITT)Clause No.10 Chapter 3 Part I, Section 1.**

5. Qualifying Criteria

Please refer ITT Clause no. 19. It will be incumbent on the part of tenderer to list specifically the details in respect of each of the sub clauses of clause 19 as to how the tenderer fulfils the qualifying criteria.

6. Last date of Submission

The tender shall be received at the address and not later than the date and time indicated in Bid Data Sheet (BDS) Chapter 5 Section I.

7. Date of Opening of Tender

The tenders will be opened at the address, date and time indicated in BDS.

8. Completion Period of Work:

The works in different sub sections/stations are to be executed concurrently such that the total work is completed & commissioned in each of the section/station within the period prescribed in Bid Data Sheet from the date of issue of “Letter of Acceptance” (LOA) of the tender.

9. Authority and address: The Authority and address to which correspondence and documents relating to the tender/contract should be sent is indicated in BDS.

10. Earnest Money

Tenderer shall deposit a sum as indicated in Bid Data Sheet (BDS) Chapter 5 Section I as Earnest Money in a manner prescribed in ITT Clause 7.

11. Security Deposit

On receipt of Letter of Acceptance of Tender from the RailTel, the successful tenderer shall be required to deposit an amount towards Security Deposit in terms of General Conditions of Contract Clause 16 Section I Chapter – 3 Part II for due fulfillment of contract.

12. Specifications

Reference of specifications of the important equipments and materials required for execution of the contract is given in the schedule of requirement and Technical supplement (Section-II of Tender document). The work shall be executed in compliance with all the technical requirements given therein.

13. Schedule of Requirement

The various items to be supplied and services to be provided by the tenderer are indicated in Schedule of Requirement as enclosed (Section 1, Chapter 7). The make and model of all the equipments/materials proposed to be supplied must be indicated by the tenderer/s in the Schedule of Requirement.

The quantity indicated in the Schedule of Requirement is the estimated requirement and may change depending on the detailed survey / system design. On this and other developments, the purchaser may exercise the option of increase / decrease of the quantity of items as specified in **Clause 19 of Chapter 4, Section- I (SCC)**.

14. Supplier's Credit

Not used

15. Work to be done by the RailTel

Items of works to be done by RailTel if any are indicated in Bid Data Sheet (BDS).

16. Materials to be supplied by RailTel

16.1 Materials to be supplied by RailTel if any, for the scope of work under this tender are indicated in Bid Data Sheet (BDS).

16.2 In case any material required for this work is supplied by RailTel due to failure of contractor in timely arranging the same, it will be charged @ 19.5% over and above the accepted SOR rates.

17. Materials to be supplied by Contractor

Tenderer's special attention is invited to the fact that no material shall be arranged/supplied by RailTel for commissioning the systems. All materials including the materials covered under the Schedule of Requirement and those required to achieve the end objective as required vide Section II of the tender document including Patch chords, connectors/ adaptors and any special protection materials etc. are to be supplied by the contractor.

18. As a good tender practice, the tenderer is expected to submit giving all the information in the relevant forms attached as Annexures to this document and suitably numbering each page of the bid documents with a content list indicating availability of various documents with their serial numbers. In the absence of numbering of pages and the content list, there is a likelihood of any important document going unnoticed for which the tenderer shall be solely responsible.

19. Maintenance Support

The tenderer should submit their strategy for providing maintenance support during warranty and post warranty period in terms of Clause no. 24 (Maintenance of Works), Clause no.27 (Placing in Service & Maintenance supervision) and Clause No. 29 (Warranty) of SCC.

20. Not used.

21. **Form C** if required by contractor for respective section/s as specified in clause 2.4, shall be issued from the office of Regional General Manager, Northern Region, Delhi (Clause 38.2 of SCC). Necessary Road permits to reach the equipment into the specified section/s shall be arranged by the contractor through the respective state authorities wherever required.

SECTION-I

Chapter-3

PART I

INSTRUCTIONS TO TENDERERS AND CONDITIONS OF TENDERING

INDEX

Clause No.	Content
1.	General Instructions
2.	Interpretations & Definations
3.	Tender Form
4.	Errors, Omissions And Discrepancies
5.	Local Conditions
6.	Compliance to Tender Conditions, Specifications and Drawings
7.	Earnest Money/Bid Guarantee
8.	Care in Submission of Tenders
9.	Right of RailTel to deal with Tenders
10.	Submission of Offers
11.	Constitution of Firm and Power of Attorney
12.	Unit Prices
13.	Validity of Offer
14.	Rates During Negotiations
15.	Income Tax Clearance Certificate & WORKS CONTRACT TAX
16.	Period of Completion and Time Progress Graph
17.	Opening of Tender
18.	Consortium Bids

19. Qualifying Criteria
20. Meaning of Similar Works
21. System Performance Guarantee
22. Evaluation of Offer
23. Execution of Contract
24. Foreign Exchange
25. Tenderer's Address
26. Preference to Public Sector Undertaking



SECTION – I

Chapter – 3

PART - I

INSTRUCTIONS TO TENDERERS & CONDITIONS OF TENDERING

1. GENERAL INSTRUCTIONS

- 1.1 These Regulations for Tenders and Contracts shall be read in conjunction with the General Conditions of Contract, which are referred to herein and shall be subject to modifications, additions or supersession by Special Conditions of Contract and/or Special Specifications, if any, annexed to the Tender Forms.

2. INTERPRETATIONS & DEFINITIONS OF SOME GENERAL TERMS

The following terms wherever occurring in the tender papers and wherever used throughout the execution of the work, shall, unless excluded by or repugnant to the context, have the meaning attributed thereto as follows:

“Tender Document”

The Special Conditions of Contract (SCC), Instructions to Tenderers and Conditions of Tendering (ITT), General Conditions of Contract (GCC), Bid Data Sheet (BDS), Technical Specifications & Supplement, Preamble including Schedule of Requirements (SOR), all Annexures, Forms, Corrigendum & Addendum issued, if any, etc. shall, hereafter, be collectively referred to as the **"Tender Document"**.

“RailTel” shall mean Office of General Manager (Northern Region) of RAILTEL CORPORATION OF INDIA LIMITED, (a Company with its Registered and regional office at 6th Floor, Block-III, Delhi IT Park, Shastri Park, Delhi – 110 053) or its authorised Officers or other Employees authorised to deal with any matters with which these persons are concerned, on its behalf.

“Regional General Manager” shall mean the officer incharge for the general superintendence and control of the RailTel’s Northern region and shall mean and include their successors of this region of RailTel.

"CONTRACT" shall mean the Contract resulting from the acceptance by the Purchaser of this Tender whether in whole or in part. **“Contract”** shall mean and include the Agreement of Work Order, the accepted schedule of rates or the Schedule of Rates of RailTel modified by the tender percentage for items of works quantified or not quantified, the General Conditions of Contract, the Special Conditions of Contracts, if any, the drawings, the specifications, the special specifications, if any, and tender forms, if any, and the document submitted by the Tenderer which have been specifically been accepted by RailTel.

"CONTRACTOR" shall mean the successful Tenderer, i.e., the Tenderer whose Tender has been accepted either in whole or in part and shall include their personal representatives, successors and permitted assigns.

'TENDER SPECIFICATIONS' shall mean the Special Conditions, Technical Specifications, appendices, Site information and drawings pertaining to the work for which the tenderers are required to submit their offer.

"CONTRACTOR's REPRESENTATIVE" shall mean a person in supervisory capacity who shall be so declared by the Contractor and who shall be authorized under a duly executed power of attorney to receive materials issued by the Purchaser to the Contractor for the works. He shall be responsible for proper execution of works at each or all places and shall take orders from Purchaser's Engineers and carry out the same.

'LETTER OF INTENT / WORK ORDER' shall mean the intimation by a letter / telegram / telex / fax to the tenderer that the tender has been accepted in accordance with provisions contained in the letter. The responsibility of the Contractor commences from the date of issue of this letter and all the terms and conditions of contract are applicable from this date.

'COMPLETION TIME' shall mean the period by date specified in the Letter of Intent / Work Order i.e., the time allowed for completion of the work including Sundays & holidays from the date of issue of Letter of Intent / Work Order.

'PLANT' shall mean and connote the entire assembly of the plant and equipment covered by the Contract.

'EQUIPMENT' shall mean all equipment, machineries, materials, structures, electrical and other components of the plant covered by the Contract.

'TEST' shall mean and include such test or tests to be carried out by the Contractor as are prescribed in the Contract or considered necessary by RAILTEL in order to ascertain the Quality, Workmanship, Performance and Efficiency of the contracted work or part thereof.

'APPROVED', 'DIRECTED' or 'INSTRUCTED' shall mean approved, directed or instructed by RAILTEL, Northern Region.

"ENGINEER /ENGINEER-IN-CHARGE" shall mean Regional General Manager of RailTel in charge of works and shall include the senior executives of RailTel. He is responsible for ensuring that all field works covered by the contract are carried out in accordance with approved designs, drawings & specifications and conditions of contract as agreed to.

"ENGINEER'S REPRESENTATIVE" shall mean the supervisor of RailTel in direct charge of the works or any official nominated by Regional General Manager.

"EQUIPMENT" shall mean all or any equipment considered necessary by the Purchaser's Engineers for satisfactory operation, as a whole, of the installations.

"MONTH" shall mean any consecutive period of thirty days.

"MATERIALS" shall mean all equipments, components, fittings and other materials including raw materials required to complete the work.

"PURCHASER" shall mean RailTel Corporation of India Limited, Northern Region, Delhi.

"PURCHASER'S ENGINEER" shall mean the Regional General Manager of RailTel or successor who will decide all matters relating to design, manufacture, and installation and commissioning of the plant and equipment at site.

"SUB-CONTRACTOR " shall mean an individual or a firm of Contractor or a Company registered under Indian Company Act or an approved supplier of materials to whom the Contractor sublets portions of the contract.

"CONSIGNEE" shall mean the person specified in the Acceptance of Tender to whom Stores covered in the contract are to be delivered at the destination.

"INSPECTING OFFICER" shall mean the person, or organization specified in the contract for the purpose of inspection of stores of work under the contract and includes his/ their authorized representative.

"SITE" shall mean the areas to be taken up for the permanent works, together with any other area or areas as shall be determined by the Purchaser's Engineer, which may be placed at the disposal of the Contractor for the purpose of the contract and also such area or areas used for store yards, works yards or workshop in proximity of the works as the Purchaser's Engineer may have authorized as an extension of the site, irrespective of the terms and conditions under which they are occupied by the Contractor.

"BLOCK SECTION" shall mean the distance along the railway track between two consecutive Railway stations.

"TENDERER" shall mean and includes any firm of engineers or Contractors or any company or body, corporate or otherwise, who submit the Tender which has been invited.

"LIMITED TENDER" shall mean tenders invited from all or some contractors on the approved or selected list for the similar type of work executed and approved by the Purchaser.

"OPEN TENDER" shall mean the tenders invited in open and public manner and with adequate notice.

"WORK OR WORKS" shall mean all or any of the items of the work for which the Tenderer/Contractor has Tendered/contracted according to the specifications, drawings and Annexure hereto annexed or to be implied there from, or incidental thereto or to be hereafter specified or required in such explanatory instructions and drawings, being in conformity with the original specifications, drawings, Annexure and schedules and also such instructions and drawings additional to the aforementioned as may from time to time be issued by the Purchaser's Engineer during the progress of the contracted work.

"SPECIFICATIONS" shall mean the specifications for materials and works of the RailTel issued under the authority of the Regional General Manager or as amplified / added to / or supported special specifications if any, appended to the tender forms.

"DRAWINGS" shall mean the map, drawings, plans and tracings or prints thereof annexed to the tender forms and shall include any modifications of such drawings and further drawings as may be issued by the Regional General Manager time to time.

"WRITING" includes all matters written, typewritten or printed either in whole or in part.

3. **TENDER FORM:** Tender Forms shall embody the contents of the contract documents either directly or by reference. Tender Forms shall be issued on payment of the prescribed fees or downloaded from the website of the RailTel, be furnished with Tender Forms and they shall be required to submit evidence regarding their financial status, previous experience and ability to execute the works, without which their tenders will not be considered.

4. **ERRORS, OMISSIONS AND DISCREPANCIES:** Should a Tenderer find discrepancies or omissions from the drawings or any of the Tender Forms or should he be in doubt as to their meaning, he should at once notify the authority inviting tenders who may send a written instruction to all tenderers. It shall be understood that every endeavor has been made to avoid any error which can materially affect the basis of the tender and the successful tenderer shall take upon himself and provide for the risk of any error which may subsequently be discovered and shall make no subsequent claim on account thereof.

In case of any contradiction only the printed rules and books should be followed and no claim for the mis-interpretation shall be entertained.

5. **LOCAL CONDITIONS**

5.1 It will be imperative on each tenderer to fully acquaint himself with all the local conditions and factors which would have any effect on the performance of the contract and cost of the stores. The purchaser shall not entertain any request for clarifications from the tenderer regarding such local conditions. No request for the change of price, or time schedule of delivery of stores shall be entertained on account of any local condition or factor after the offer is accepted by the purchaser.

5.2 The intending tenderer is advised to study the tender documents carefully. Submission of a quotation by the tenderer shall be deemed to have been done after a careful study and examination of these documents with full understanding of the implication thereof. These conditions and specifications shall be deemed to have been accepted unless otherwise, specifically commented upon by the Tenderer in his quotation. Failure to adhere to anyone or all these instructions may render his offer liable to be ignored without any reference.

6. **COMPLIANCE TO TENDER CONDITIONS, SPECIFICATIONS & DRAWINGS**

6.1 The tenderer shall indicate clause by clause for each section of the tender document that either his tender complies in every respect with the requirements of each clause and sub clause or if not, precisely how they differ from the requirements of the tender. In later case, the tenderer shall enclose a separate statement as per proforma (see Form 5 of Section-I, Chapter-6), indicating only the deviations for any clause or sub clause of Special Conditions of Contract, Instructions to Tenderers and General Conditions of Contract, Technical Specifications, Preamble etc. which he proposes with justifications for deviations proposed. The purchaser reserves the right to accept or reject these deviations and his decision thereon shall be final

6.2 The tenderer should serially number all the pages of the bid. The tenderer should provide information about the compliance of various clauses /sub clauses/ paragraphs (when tenderer plans to give separate compliance of each paragraph or sub clause) of the tender document as per following table:

S.N.	Clause no. with chapter	First few words of clause / sub	Compliance status	Reference of clause /page no. of supporting	Remarks if any
------	-------------------------	---------------------------------	-------------------	---	----------------

		clause / paragraph		document (this page no. shall correspond to the serial numbering of the bid)	

The table given above, duly filled in all respects, must be submitted along with offer.

In case of “NIL” deviation also, the information must be submitted in Form-5 Chapter 6 Section I.

- 6.3 Firms should give as proof of work experience {Form (2) and Form (13)}. Details of works executed giving details of the name of the project, date of award, length of the section, No. of Stations, value of the contract, the original execution period and the actual execution time taken. The certificate from the actual user about the satisfactory performance indicating all the details as given herein shall be enclosed with the tender.

7. **EARNEST MONEY**

- 7.1 The Tenderer shall be required to deposit earnest money with the Tender for the due performance of the stipulation to keep the offer open till such date as specified in the Tender under the conditions of Tender.

- (a) The earnest money shall be 2% of the estimated tender value or as indicated in Tender Notice. The exact amount of Earnest Money required to be deposited is indicated in Bid Data Sheet (BDS) Chapter 5 Section I.
- (b) The tenderers shall hold the offer open till such date as specified in Clause 13 of this chapter. It being understood that the tender documents have been sold/issued to the tenderer and the tenderer has been permitted to tender in consideration of stipulation on his part, that after submitting his tender he will not resile from his offer or modify the terms and conditions, thereof in a manner not acceptable to RailTel. If the tenderer fails to observe or comply with the foregoing stipulation the aforesaid amount deposited as earnest money shall be liable to be forfeited by the RailTel.
- (c) If his tender is accepted this earnest money mentioned in sub clause (a) above will be retained as part security for the due and faithful fulfillment of the contract in terms of Clause 16 of the General Conditions of Contract. The Earnest Money of other tenderers shall, save as herein before provided, be returned to them, but RailTel shall not be responsible for any loss or depreciation that may happen thereto while in their possession, nor be liable to pay interest thereon.

- 7.2 The earnest money should be in any of the following forms:

- 7.2.1 Pay orders and demand drafts. These forms of earnest money could be either of the State Bank of India or of any of the nationalized banks. No confirmatory advice from the Reserve Bank of India will be necessary.
- 7.2.2 Deposit receipt executed by the scheduled banks (other than the State Bank of India and the Nationalized Banks) approved by the Reserve Bank of India for this purpose. The RailTel will not, however, accept deposit receipt without getting in writing the concurrence of the Reserve Bank of India.

- 7.3 The Earnest Money receipt shall be incorporated in the original copy of the Bid. Other copies of the offer shall contain true copies of Earnest Money receipt.
- 7.4 Pay Orders or Demand Drafts shall be drawn in favour of RailTel Corporation of India Limited, payable at Delhi and endorsed "Account Payee". These instruments should be valid at least for the period covering 90 days beyond the validity of the offer.
- 7.5 The bid guarantee / earnest money may be forfeited:
- 7.5.1 If a tenderer withdraws its tender during the period of tenders validity specified in clause 13 of Instructions to Tenderers and Conditions of Tendering. In the case of successful tenderer, if the tenderer fails to Sign the contract in accordance with Clause 2 of Special Conditions of Contract and to furnish performance guarantee in accordance with Clause 3 of Special Conditions of Contract.
- 7.5.2 The Earnest Money of unsuccessful tenderer will save as herein before provided, be returned within reasonable time to the unsuccessful tenderer but the RailTel shall not be responsible for any loss or depreciation that may happen to the security for the due performance of the above stipulation to keep offer open for the period specified in the tender documents or to the Earnest Money while in their possession nor be liable to pay interest thereon.
- 7.5.3 Tender not accompanied by Earnest Money will be summarily rejected.

8. Care in Submission of Tenders

- (a) Before submitting a tender, the tenderer will be deemed to have satisfied himself by actual inspection of the site and locality of the works, that all conditions liable to be encountered during the execution of the works are taken into account and that the rates he enters in the tender forms are adequate and all inclusive to accord with the provisions in Caluse-37 of the General conditions of Contract for the completion of works to the entire satisfaction of the Engineer.
- (b) When work is tendered for by a firm or company of contractors, the tender shall be signed by the individual legally authorized to enter into commitments on their behalf.
- (c) The RailTel will not be bound by any power of attorney granted by the tenderer or by changes in the composition of the firm made subsequent to the execution of contract. It may, however recognize such power of attorney and changes after obtaining proper legal advice, the cost of which will be chargeable to the contractor.

9. Right of RailTel to deal with Tenders

- 9.1 The RailTel reserves the right of not to invite tenders for any of RailTel work or works or to invite open or limited tenders and when tenders are called to accept a tender in whole or in part or reject any tender or all tenders without assigning reasons for any such action.
- 9.2 The authority for the acceptance of the tender will rest with the RailTel. It shall not be obligatory on the said authority to accept the lowest tender or any other tender and no tenderer (s) shall demand any explanation for the cause of rejection of his/their tender nor the RailTel undertake to assign reasons for declining to consider or reject any particular tender or tenders.
- 9.3 If the Tenderer (s) deliberately gives/give wrong information in his/their tender or creates/create circumstances for the acceptance of his/their tender, the RailTel reserves the right to reject such tender at any stage.

9.4 If the Tenderer (s)/Partner(s) expire after the submission of his/their tender or after the acceptance of his/their tender, the RailTel shall deem such tender cancelled, unless the firm retains its character.

10. SUBMISSION OF OFFERS

10.1 All offers in the prescribed forms should be submitted before the time and date fixed for the receipt of the offers. Offers received after the stipulated time and date will be summarily rejected.

10.2 In case the date of opening happens to be a holiday, the tender will be received and opened at the same time on the next working day.

10.3 All offers shall be either type written or written neatly in indelible ink in English. Each page of the offer must be numbered consecutively. A reference to total number of pages comprising the offer must be made at the top right hand corner of the top page. The supporting documents should be submitted either in original or duly signed by the authorized signatory of the tenderer. The original documents shall be produced for verification when called for.

10.4 All copies of the tender papers shall be signed in ink by the tenderer, on each page including closing page in token of his having studied the tender papers carefully.

10.5 In case tenderer considers necessary to include new item of work not included in schedule of requirement but considered necessary for achieving the end objective he may do so by submitting a new schedule of requirement marked as "C" quoting the rates and quantities along with the detailed justification.

10.6 RATES IN FIGURES & WORDS

(i) All prices and other information like discounts etc. having a bearing on the price shall be written both in figures and in words in the prescribed offer form. In case of difference in words and figures the amount written in words will be taken into consideration.

(ii) In the event of any discrepancy between unit rate and total cost, the value shown in unit rate will be taken for evaluation purpose.

(iii) In case the schedule of requirement quoted by tenderer is incomplete with reference to tender document, the offer is liable to be rejected.

10.7 **ATTESTATION OF ALTERATION:** No scribbling is permissible in the tender documents. Tender containing erasures and alterations in the tender documents are liable to be rejected. Any correction made by the tenderer/ tenderers in his/their entries must be signed (not initialed) by him/them.

10.8 The tenderer shall submit his tender in sealed cover. The tender shall be complete in all respects. The original tender paper purchased from this office or down loaded from the RailTel web site shall be returned duly signed on each page along with the offer.

10.9 **Tender Bid:** The envelope should bear the Tender No., its description and date of closing/opening. The complete Tender Bid shall be addressed to:

The Regional General Manager,

Northern Region,
RailTel Corporation of India Limited,
6th floor, Block-III, Delhi IT Park,
Shastri Park
Delhi-110 053

10.10 The bid shall consist of the following:-

- 1) Offer Letter complete. (Form No.1 of Section-I, Chapter-6)
- 2) Schedule of Requirements duly filled (Section-I,Chapter-7).
- 3) Earnest Money in prescribed form. (Clause 7 of Section-I, Chapter-3)
- 4) Not used.
- 5) Constitution of Firm and Power of Attorney (Clause 11)
- 6) Clause wise compliance to tender conditions & statement of deviations (Clause 6). (Form No.5 of Chapter-6, Section-I)
- 7) Similar works executed or under execution. (Form No.13) (Clause 19.1.3)
- 8) User's Certificate (Form No. 2 of chapter-6, Section-I) (Clause 19.1.4)
- 9) System performance guarantee (Clause 21) of Section 1, Chapter 3 Part I. (Form No.7)
- 10) Complete technical data and particulars of the equipment offered, as specified in the Tender papers together with descriptive literature, leaflets, Drawings, if any, complete with list etc. (Clause 19.4).
 - 1) Name of manufacturers, place of manufacture and documentary proof of equipment being proven and working for more than one year along with user certificate clearly indicating the date of commissioning in the user network.
 - 12) Not used .
 - 13) Any other information desired to be submitted by the tenderer.
 - 14) The present work load of the telecom contracts in hand as per the format (Form No.9).

10.11 There is one **SOR: SOR (A) for Schedule Items** for which should quote a single percentage above/below in the Tenderer offer given at the End of SOR (A).

11. CONSTITUTION OF FIRM AND POWER OF ATTORNEY

11.1 Any individual(s) signing the tender or other documents connected therewith should specify whether he is signing:-

- (a) As sole proprietor of the concern or as attorney of the sole proprietor;
 - (b) As a partner or partners of the firm;
 - (c) As a Director, Manager or Secretary in the case of Limited Company duly authorized by a resolution passed by the Board of Directors or in pursuance of the authority conferred by Memorandum of Association.
- 11.2 In the case of a firm not registered under the Indian Partnership Act, all the partners or the attorney duly authorized by all of them should sign the tender and all other connected documents. The original Power of Attorney or other documents empowering the individual or individuals to sign should be furnished to the Purchaser for verification, if required.
- 11.3 The RailTel will not be bound by Power of Attorney granted by the tenderer or by the changes in the composition of the firm made subsequent to the execution of the contract agreement.
- 11.4 In case where the Power of Attorney partnership deed has not been executed in English, the true and authenticated copies of the translation of the same by Advocate, authorized translators of Courts and Licensed Petition Writers should be supplied by the Contractor(s) while tendering for the work.
- 11.5 The duly notarised Power of Attorney, Partnership Deed, Memorandum of Joint Venture as the case may be in original or duly signed.

12. **UNIT PRICES**

The Unit prices should be quoted by the Contractor as an all inclusive price, after taking all the relevant factors into consideration and these should be Firm and all inclusive without any variation clauses. These shall include all taxes & duties such as excise duty, sales tax, works contract tax, service tax & octroi etc. as payable under the law of land and purchaser shall not accept any liability for the same after award and acceptance of contract. The prices shall be quoted in Indian Rupees for the units under metric system. Reference may be made to **Clause 38** of Special Conditions of Contract. Bids not confirming to **clause 38** of SCC will be summarily rejected.

13. **VALIDITY OF OFFER**

The tenderer shall keep the offer open for a minimum period as indicated in Bid Data Sheet from the date of opening of tender. Within that period the tenderer cannot withdraw his offer subject to the period being extended further, if required, by mutual agreement from time to time. Any contravention of the above condition will make the tenderer liable for forfeiture of his Earnest Money.

14. **RATES DURING NEGOTIATION**

The tenderer/s shall not increase his/their quoted rates including payment terms in case the RailTel Administration negotiates for reduction of rates. Such negotiations shall not amount to cancellation or withdrawal of the original offer and the rates originally quoted will be binding on the tenderer/s.

15. **INCOME TAX CLEARANCE CERTIFICATE (ITCC) AND WORKS CONTRACT TAX CERTIFICATE.**

I. Deleted

II. The successful tenderer is required to be registered with the commercial tax authorities of the respective states where the work is to be executed for WCT. The WCT registration numbers of the successful tenderer with the concerned states shall be a pre-requisite before raising the bill for payment.

16. **PERIOD OF COMPLETION AND TIME PROGRESS GRAPH**

16.1 The works/work are/is to be completed within a period as mentioned in Bid Data Sheet (BDS) from the date of issue of Letter of Acceptance of the tender.

16.2 The Tenderers should submit the bar chart including each activities of the Schedule of Requirements indicating his planning to complete the work within the stipulated completion period.

17. **OPENING OF TENDER:**

17.1 Tenderer's Bid will be opened at the time & date of opening of the tender given in the Bid Data Sheet (BDS) in presence of such Tenderers/Representatives who choose to be present.

17.4 **NON-TRANSFERABILITY AND NON-REFUNDABILITY**

The tender documents are not transferable. The cost of tender paper is not refundable.

18. **CONSORTIUM BIDS**

Deleted

19. **QUALIFYING CRITERIA**

19.1 General:

19.1.1 Qualifying criteria under this para lays down minimum acceptable qualifications in various areas to ensure that qualified tenderer has necessary experience, technical expertise, equipments and financial and human resources to successfully complete the project.

19.1.2 **ELIGIBILITY CRITERIA & TECHNICAL REQUIREMENTS FOR QUOTING IN THIS TENDER**

19.1.3 The work covered by this tender is extremely skilled and technical in nature and only the firms having sufficiently skilled and experienced staff with them and who have carried out tight targeted Telecom works shall quote against this Tender.

19.1.4 The tenderer shall necessarily satisfy the eligibility conditions as listed below:-

1.1 The tenderer should have completed in the last three financial year (i. e. current year and three previous financial years) at least one similar single work for a minimum value of 35% of the

advertised tender value of the work.

- 1.2 Similar nature of work physically completed within the qualifying period, i.e. the last 3 financial year and current financial year (even though the work might have commenced before the qualifying period) shall only be considered in evaluating the eligibility criteria.
- 1.3 The total value of similar nature of work completed during the qualifying period and not the payments received within qualifying period alone, shall be considered.

(For this tender “similar single work” means one complete work involving:

“Trenching, Laying, Jointing, Splicing, Termination, Testing and Commissioning of Optical Fiber Cables.”)

- 2 The total contact amount received by the tenderer during the last three years should be a minimum of 150% of the advertised tender value of the work. (Last audit report from registered Chartered Accountant to be enclosed).

19.2 TECHNICAL REQUIREMENTS

Tenderer must have proper Office Set up, Man power, Equipments and Machinery as follows:

- (i) **Office Setup:** Tenderer should have a proper office with regular staff, Computers, Fax Machine and Telephone.
The Office Address, Telephone No, Fax No., E-mail ID must be specified.
- (ii) **Minimum Technical Man Power:** Tenderer should have:
 1. Engineer - 1No.
 2. Supervisor (Diploma Holder) - 1 No.
 3. Splicer (Skilled & Experienced) - 1No.
 4. Wireman/Cable Jointer (ITI) - 2 Nos.
 5. Skilled & Unskilled Man Power - (Sufficient)
- (iii) **Minimum Equipments / Machinery :** Tenderer should own :
 1. OTDR
 2. OFC Blowing Machine
 3. Splicing Machine
 4. Cable Route Locator
 5. Optical Power Meter
 6. Laser Source

7. HDD Machine

8. Loading Vehicle

Table to be submitted duly filled: (Annexure-I)

Eligibility Clause No	Actual Available	Whether Requirement Fulfilled (Yes/No)	Documentary evidence enclosed at
<p>19.1.4</p> <p>1.1 The tenderer should have completed in the last three financial year (i. e. current year and three previous financial years) at least one similar single work for a minimum value of 35% of the advertised tender value of the work.</p> <p>1.2 Similar nature of work physically completed within the qualifying period, i.e. the last 3 financial year and current financial year (even though the work might have commenced before the qualifying period) shall only be considered in evaluating the eligibility criteria.</p> <p>1.3 The total value of similar nature of work completed during the qualifying period and not the payments received within qualifying period alone, shall be considered.</p>			
<p>19.1.4 (2)</p> <p>The total contact amount received by the tenderer during the last three years - Should be a minimum of 150% of the advertised tender value of the work.</p>			
<p>19.2.(i) Office setup:</p> <p>1.Office Address,</p> <p>2.Telephone No ,</p> <p>3. Fax No.</p> <p>4.E-mail ID</p>			
<p>19.2.(ii) Man Power:</p> <p>1. Engineer</p> <p>2.Supervisor</p> <p>3.Splicer(Skilled&Experienced)</p> <p>4.Wireman/CableJointer</p> <p>5.Skilled & Unskilled Man Power</p>			

19.2.(iii)Equipments/Machinery 1. OTDR 2. OFC Blowing Machine 3. Splicing Machine 4. Cable Route Locator 5. Optical Power Meter 6. Laser Source 7. HDD Machine 8. Loading Vehicle			
--	--	--	--

Signature of Contractor

19.3 Not Used

19.4 Equipment/Material

19.4.1 The tenderer shall clearly identify the sources from which the equipment/ material to be supplied under this tender will be obtained. The tenderer should also enclose an undertaking from the sources, from where he is procuring the material to the effect that the material shall be supplied in time so as to enable the tenderer to complete the work within completion period.

19.4.2 All equipments/ materials proposed to be used shall be of proven design and performance. The equipment/ materials shall has been successfully commissioned and remained in satisfactory service atleast for a period of two years on date of tender submission. Certificate from the actual user of the equipment about satisfactory performance shall be enclosed with the tender.

19.4.3 The equipoments / materials shall be covered by performance guarantee by the contractor duly supported by the original manufacturer.

19.5 Not Used.

19.6 Not used.

19.7 WORK LOAD

The tenderer submit the present workload of the telecom. Contracts in hand as per the format (Form No.9 of Section-I, Chapter-6). The performance of the tenderer with regard to satisfactory execution of more than one contract simultaneously in the past shall be taken into account.

20. MEANING OF SIMILAR WORKS

20.1 Works similar to the scope of work as contained in this tender shall mean

i) OFC works including Trenching, Laying, Jointing, Splicing, Testing and Commissioning of Optical Fibre Cables/ Telecom Cable works.

(OR)

ii) Installation & Commissioning of public Wi-Fi networks in Railway Stations / Metro Railway Stations/ Airports / Bus Terminals/ Ship Terminals / reputed Malls/ Residential/ commercial buildings and Offices.

The work should have been executed for Govt. / PSUs / Telecom Service Providers / IT Infrastructure Providers.

21. SYSTEM PERFORMANCE GUARANTEE

- 21.1 The tenderer shall give unqualified and unconditional guarantee that when the equipment / material supplied by him is installed and commissioned at site, it shall achieve the desired objective and that in the event of performance of the system when installed not complying with the end objective or with the specifications, he shall provide further inputs to enable the RailTel to realize the end objectives with full compliance of the specifications contained in these documents. No additional payment will be made to the contractor for supply of any additional goods and service required in this regard.
- 21.2 This certificate in the proforma given in Form No. 7, shall accompany the final offer. Absence of this certificate which will form part of the agreement shall disqualify the tenderer automatically.
- 21.3 In case the tender is not the original equipment manufacturer, the unqualified & unconditional support to be provided by the original equipment manufacturer for the equipment to be supplied against this tender should be submitted by the tenderer.

22. EVALUATION OF OFFER

The authority for the acceptance of the tender rests with the Purchaser. The tenders received will be evaluated by the Purchaser to ascertain the best acceptable tender in the interest of the Purchaser.

However, the purchaser shall not be bound to accept the lowest or any tender or to assign any reason for non-acceptance or rejection of a tender. "The purchaser reserves the right to accept any tender in respect of the whole or any portion of the work specified in the tender paper or to sub-divide the work among different Tenderers or to reduce the work or to accept any tender for less than the tendered quantities without assigning any reason whatsoever".

23. EXECUTION of CONTRACT

- 23.1 The Tenderer whose tender is accepted shall be required to appear in person in the office of Regional General Manager, RailTel Northern Region or in the office of concerned Engineer, as the case may be or if a firm or corporation, a duly authorized representative shall so appear and execute the contract documents within 15 days after the contract has been awarded to him as indicated in Clause 2 of Special Conditions of Contract (SCC). Failure to do so shall constitute a breach of the agreement affected by the acceptance of the tender in which case the full value of the earnest money accompanying the tender shall stand forfeited without prejudice to any other rights or remedies.
- 23.2 In the event of any tenderers whose tender is accepted shall refuse to execute the contract documents as herein before provided, the RailTel may determine that such tenderer has abandoned the contract and thereupon his tender and acceptance thereof shall be treated as cancelled and RailTel shall be entitled to forfeit the full amount of the Earnest Money and to recover the damages for such default.

24. Deleted

25. **TENDERER'S ADDRESS**

Tenderer shall state in the tender his postal address fully and clearly. Any communication sent to the tenderers by post at the said address shall be deemed to have reached the tenderer duly & timely, notwithstanding the fact that the communication could not reach the tenderer at all or in time for whatever reason. Important documents shall be sent by Registered Post/ Speed post/Couriers.

26. **PREFERENCE TO PUBLIC SECTOR UNDERTAKING**

Due preference as per the extant rules applicable on the day of opening of this tender will be given to Central Public Sector Undertakings as per Government of India, Department of Public Enterprises letter No. DPE 13 (12) 2003-Fin.Vol.II dated 18.07.2005, or latest.



SECTION-I

Chapter-3

PART II

GENERAL CONDITIONS OF CONTRACT

1. Definitions
2. General Obligations
3. Law governing the Contract
4. Communications to be in writing
5. Service of Notices on Contractors
6. Occupations and use of land
7. Assignment or subletting of contract
8. Assistance by the RailTel for the stores be obtained by the Contractor
9. Railway Passes
10. Carriage of materials
11. Force Majeure Clause
12. Representation on Works
13. Relics and Treasures
14. Excavated material
15. Indemnity by Contractors
16. Earnest Money and Security Deposit
17. Completion Period
18. Illegal Gratification
19. Execution of Works
20. Compliance to Engineer's Instructions
21. Instructions of Engineer's Representative
22. Adherence to specifications and drawings

23. Working during night
24. Damage to RailTel property or private life and property
25. Sheds, Stores houses and Yards
26. Provision of efficient and competent staff
27. Workmanship and Testing
28. Facilities for Inspection
29. Examination of work before covering up
30. Temporary works
31. Contractors to supply water for works
32. Property in material and plants
33. Tools, Plant and Materials supplied by the RailTel
34. Precaution during progress of work
35. Use of Explosives
36. Suspension of works
37. Rates for items of works
38. Demurrage and wharfage dues
39. Rates for extra items of works
40. Handing over of works
41. Modification to Contract to be in writing
42. Powers of Modification to Contract
43. Monthly Statement of Claims
44. Qualities in schedule annexed to Contract
45. Measurements of Works
46. "On-Account" Payment
47. Maintenance of works
48. Certificate of Completion of Works

49. Approval only by Maintenance Certificate
50. Maintenance Certificate
51. Final payment
52. Withholding and lien in respect of sums claimed
53. Signature on Receipts for Amounts
54. Wages to Labour
55. Provisions of Payments of Wages Act
56. Reporting of Accidents to Labour
57. Provisions of Workmen's Compensation Act
58. RailTel not to provide quarters for Contractor
59. Labour camps
60. Non-Employment of Labourers below the age of 15
61. Determination of Contract
62. Termination of contract owing to default of contractor
63. Matters finally determined by the RailTel
64. Settlement of dispute and Arbitration



SECTION – 1

Chapter - 3

PART II

GENERAL CONDITIONS OF CONTRACT FOR USE IN CONNECTION WITH RAILTEL'S WORKS

DEFINITIONS AND INTERPRETATION

1. Definitions:

- 1.1 The meaning of terms/interpretations shall be taken as defined in Chapter-3 Part- I of Section - 1 (INSTRUCTIONS TO TENDERERS AND CONDITIONS OF TENDERING).
- (a) “**Constructional Plant**” shall mean all appliances or things of whatsoever nature required for the execution, completion or maintenance of the works or the temporary works (as hereinafter defined) but does not include materials or other things intended to form or forming part of the permanent work.
- (b) “**Temporary Works**” shall mean all temporary works of every kind required for the execution, completion and/or maintenance of the works.
- (c) “**Period of maintenance**” shall mean the specified period of the maintenance from the date of completion of the work as certified by the Engineer.
- 1.2 **Singular and Plural:** Works importing the singular number shall also include the plural and vice versa where the context requires.
- 1.3 **Headings & marginal headings:** The headings and marginal headings in these general conditions are solely for the purpose of facilitating reference and shall not be deemed to be part thereof or be taken into consideration in the interpretation or construction thereof or the contract.

2. GENERAL OBLIGATIONS

2.1 Execution Co-relation and intent of contract documents: -

The contract documents shall be signed in triplicate by the RailTel and the Contractor. The contract documents are complementary, and what is called for by any one shall be as binding as if called of try all; the intention of the documents is to include all labour and materials, equipments and transportation necessary for the proper execution of work. Materials or work not covered by or properly inferable from any heading or class of the specifications shall not be supplied by the RailTel to the contractors unless distinctly specified in the contract documents. Materials or works described in words, which so applied, have a well-known technical or trade meaning shall be held to refer to such recognized standards.

- 2.2 If a work is transferred from the jurisdiction of one region of RailTel to another region or to a Project authority or vice versa while contract is in subsistence, the contract shall be binding on the Contractor and the other region in the same manner & take effect in all respects as if the Contractor

and the other region were parties thereto from the inception and the corresponding officer or the competent authority in the other region will exercise the same powers and enjoy the same authority as conferred to the Predecessor RailTel/Project under the original contract/agreement entered into.

- 2.3 If for administrative or other reasons the contract is transferred to the other region of RailTel the contract shall notwithstanding anything contained herein contrary thereto, be binding on the Contractor the and the other region in the same manner and take effect in all respects as if the contractor and the other region had been parties thereto from the date of this contract.
3. **Law Governing the Contract:**
- 3.1 The Contract shall be govern by the law for the time being in the republic of India.
- 3.2 Compliance to regulations and bye-laws – The Contractor shall conform to the provision of any statute relating to the works and regulations and bye-laws of any local authority and of any water and lighting companies or undertakings, with whose system the work is proposed to be connected and shall before making any variation from the drawings or the specifications that may be necessitated by so confirming give to the Engineer notice specifying the variation proposed to be made and the reason for making the variation and shall not carry out such variation until he has received instructions from the Engineer in respect thereof. The Contractor shall be bound to give all notices required by statue, regulations or bye-laws as aforesaid and to pay all fees and taxes payable to any authority in respect thereof.
4. **Communications to be in writing** – All notices, communications, references and complaints made by the RailTel or the Engineer or the Engineer’s representative or the Contractor interest concerning the works shall be in writing and no notice, communication, references or complaint not in writing shall be recognized.
5. **Service of Notices on Contractors** – The Contractor shall furnish to the Regional General Manager /RailTel the name, designation and address of his authorized agent and all complaints, notices, communications and references shall be deemed to have been duly given to the contract if delivered to the Contractor or his authorized agent or left at or posted to the address so given and shall be deemed to have been so given in the case of posting on day on which they would have reached such address in the ordinary course of post or on the day on which they were so delivered or left. In the case of contract by partners, any change in the constitution of the firm shall be forthwith notified by contractor to the Regional General Manager /RailTel.
6. **Occupation and use of land** – No land belonging to or in the possession of the Railway/RailTel shall be occupied by the contractor without the permission of the RailTel. The Contractor shall not use, or allow to be used, the site for any purposes other than that executing the works.
7. **Assignment or subletting of contract:** - The Contractor shall not assign or sublet the contract or any part thereof or allow any person to become interested therein in any manner whatsoever without the special permission in writing of the RailTel. Any breach of this condition shall entitle the RailTel to rescind the contract under clause 62 of these conditions and also render the contractor liable for payment to the RailTel in respect of any loss or damage arising or ensuring from such cancellation. Provided always that execution of the details of the work by petty contractor under the direct and personal supervision of the contractor or his agent shall not be deemed to be sub-letting under this clause. The permitted subletting of work by the contractor shall not establish any contractual relationship between the sub-contractor and the RailTel and shall not relieve the Contractor of any responsibility under the Contract.

8. **Assistance by the RailTel for the stores to be obtained by the Contractor:** Owing to difficulty in obtaining certain materials (including Tools & Plants) in the market, the RailTel may have agreed without any liability therefore, to endeavor to obtain or assist the Contractor in obtaining the required quantities of such materials as may be specified in the Tender. In the event of delay or failure in obtaining the required quantities of the aforesaid materials, the Contractor shall not be deemed absolved of his own responsibility and shall keep in touch with the day to day position regarding their availability and accordingly adjust progress of works including employment of labour and the RailTel shall not in any way be liable for the supply of materials or for the non supply thereof for any reasons whatsoever not for any loss or damage arising in consequence of such delay or non supply.
9. **Railway Passes** – No free Railway passes shall be issued by the RailTel to the Contractor or any of his employee/worker.
10. **Carriage of materials** – No forwarding orders shall be issued by the RailTel for the conveyance of Contractor's materials, tools and plant by Rail which may be required for use in the works and the contractor shall pay full freight at public tariff rates therefore.
11. **Force Majeure Clause**
 - 11.1 If at any time, during the continuance of this Contract, the performance, in whole or part, by either party, of any obligation under this contract shall be prevented or delayed by reason of any war, hostility, act of the public enemy, Civil Commotion, Sabotage, Fires, Floods, Earth quakes, explosions, strikes, epidemics, quarantine restrictions, lockouts, any statute, statutory rules/ regulations, order of requisitions issued by any Government Department or Competent Authority of acts of God (here-in-after referred to as event) then provided notice of the happening of any such event is given by either party to the other within twenty one days from the date of occurrence thereof, neither party shall, by reason of such event, be entitled to terminate this Contract nor shall either party have any claim for damage against the other in respect of such non- performance or delay in performance, and the obligations under the Contract shall be resumed as soon as practicable after such event has come to an end or ceased to exist, PROVIDED FURTHER that if the performance in whole or part of any obligation under this Contract is prevented or delayed by reason of any such event beyond a period as mutually agreed to by the RailTel and the Contractor after any event or 60 days in the absence of such an agreement whichever is more, either party may at its option terminate the Contract provided also that if the contract is so terminated under this clause the RailTel may at the time of such termination take over from the Contractor at prices as provided for in the contract, all works executed or works under execution.
12. **Representation on Works** – The Contractor shall, when he is not personally present on the site of the works place and keep a responsible agent at the works during working hours who shall on receiving reasonable notice, present himself to the Regional General Manager /RailTel and orders given by the Engineer or the Engineer's Representative to the agent shall be deemed to have the same force as if they had been given to the Contractor. Before absenting himself, the Contractor shall furnish the name and address of his agent for the purpose of this clause and failure on the part of the Contractor to comply with this provision at any time will entitle the RailTel to rescind the contract under Clause 62 of these conditions.
13. **Relics and Treasures** – All gold, silver, oil and other minerals of any description and all precious stones, coins, treasures, relics, antiquities and other similar things which shall be found in or upon the site shall be property of the RailTel and the Contractor shall duly preserve the same to the

satisfaction of the RailTel and shall from time to time deliver the same to such person or persons as the RailTel may appoint to receive the same.

14. **Excavated material** – The Contractor shall not sell or otherwise dispose of or remove except for the purpose of this contract, the sand, stone, clay ballast, earth, rock or other substances or materials which may be obtained from any excavation made for the purpose of the works or any building or produced upon the site at the time of delivery of the possession thereof but all the substances, materials, buildings, and produce shall be the property of the RailTel provided that the Contractor may, with the permission of the Regional General Manager /RailTel, use the same for the purpose of the works either free of cost or pay the cost of the same at such rates as may be determined by the Engineer.
15. **Indemnity by Contractors** – The Contract shall indemnify and save harmless the RailTel from and against all actions, suit proceedings, losses, costs, damages, charges, claims, and demands of every nature and description brought or recovered against the RailTel’s by reason of any act or omission of the Contractor, his agents or employees, in the execution of the works or in his guarding of the same. All sums payable by way of compensation under any of these conditions shall be considered as reasonable compensation to be applied to the actual loss or damage sustained, and whether or not any damage shall have been sustained.
16. **Security Deposit**
 - 16.1 The Earnest Money deposited by the Contractor with his tender will be retained by RailTel as part of security deposit for the due and faithful fulfillment of the contract by the contractor. The balance to make up the security deposit, may be deposited by Contractor in the form of Demand Drafts or may be recovered by percentage deduction from the contractor’s “on account” bills. Provided also that in case of defaulting contractor the RailTel may retain any amount due for payment to the Contractor on the pending “on account bills” so that the amounts so retained may not exceed 10% of the total value of the contract.
 - 16.2 Unless otherwise specified in the special conditions, if any, the rates for Deposit/ rate of recovery / mode of recovery shall be as under:
 - a) Security Deposit for each work should be 5% of the contract value.
 - b) The rate of recovery should be at the rate of 10% of the bill amount till The full security deposit is recovered.
 - c) Security Deposits will be recovered only from the running bills of the contract and no other mode of collecting SD such as SD in the form of instruments like BG, FD etc shall be accepted towards Security Deposit.

Security Deposit shall be returned to the contractor after the physical completion of the work as certified by the competent authority. The competent authority shall normally be the authority that is competent to sign the contract.
 - 16.3 No interest will be payable upon the Earnest Money and Security Deposit or amounts payable to the Contractor under the Contract.
17. **Completion Period:-**
 - 17.1 Subject to any requirement in the contract as to completion of any portion or portions of the works before completion of the whole, the contractor shall fully and finally complete the whole of the works comprised in the contract (with such modifications as may be directed under conditions of

this contract) by the date entered in the contract or extended date in terms of the following clauses:

- 17.1.2 If any modifications have been ordered which in the opinion of the Engineer have materially increased the magnitude of the work, then such extension of the contracted date of completion may be granted as shall appear to the Engineer to be reasonable in the circumstances, provided moreover that the Contractor shall be responsible for requesting such extension of the date as may be considered necessary as soon as the clause thereof shall arise and in any case not less than one month before the expiry of the date fixed for completion of the works.
- 17.1.3 If in the opinion of the Engineer the progress of work has any time been delayed by any act or neglect of RailTel's employees or by other contractor employed by the RailTel under sub-clause (4) of clause 20 of these conditions or in executing the work not forming part of the contract but on which contractor's performance necessarily depends or by reason of proceeding taken or threatened by or dispute with adjoining or neighboring owners or public authority arising otherwise through the Contractor's own default etc. or by the delay authorized by the Engineer pending arbitration` or in consequences of the contractor not having received in due time necessary instructions` from the RailTel for which he shall have specially applied in writing to the Engineer or his authorized representative then upon happening of any such event causing delay, the contractor shall immediately give notice thereof in writing to the Engineer within 15 days of such happening but shall nevertheless make constantly his best endeavors to bring down or make good the delay and shall do all that may be reasonably required of him to the satisfaction of the Engineer to proceed with the works. The contractor may also indicate the period for which the work is likely to be delayed and shall be bound to ask for necessary extension of time. The engineer on receipt of such request from the contractor shall consider the same and shall grant such extension of time as in his opinion is reasonable having regard to the nature and period of delay and the type and quantum of work affected thereby. No other compensation shall be payable for works so carried forward to the extended period of time, the same rates, terms and conditions of contract being applicable as if such extended period of time was originally in the original contract itself.
- 17.1.4 In the event of any failure or delay by the RailTel to hand over the Contractor possession of the lands necessary for the execution of the works or to give the necessary notice to commence the works or to provide the necessary drawings or instructions or any other delay caused by the RailTel due to any other cause whatsoever, then such failure or delay shall in no way affect or vitiate the contract or alter the character thereof or entitle the contractor to damages or compensation therefore but in any such case, the RailTel may grant such extension or extensions of the completion date as may be considered reasonable.
- 17.2 **Extension of time for delay due to contractor** – The time for the execution of the work or part of the works specified in the contract documents shall be deemed to be the essence of the contract. If the contractor fails to complete the works within the time as specified in the contract for the reasons other than the reasons specified in clause 11 and 17.1 above, the RailTel may, if satisfied that the works can be completed by the contractor within reasonable short time thereafter, allow the contractor further extension of time as the Engineer may decide. On such extension the RailTel will be entitled without prejudice to any other right and remedy available on that behalf, to recover from the contractor as agreed damages and not by way of penalty a sum equivalent to 1/2% of the contract value of the works for each week or part of the week.
- 17.2.1 For the purpose of this clause, the contract value of the works shall be taken as value of work as per contract agreement including any supplementary work order/contract agreement issued. Provided also, that the total amount of liquidated damages under this condition, shall not exceed 10% of the total value of the contract. Provided further, that if the RailTel is not satisfied that the works can be

completed by the Contractor and in the event of failure on the part of the contractor to complete the work within further extension of time allowed as aforesaid, the RailTel shall be entitled, without prejudice to any other right or remedy available in that behalf, to appropriate the contractor's security deposit and rescind the contract under clause 62 of these conditions, whether or not actual damage is caused by such default.

18. Illegal Gratification

18.1 Any bribe, commission, gift or advantage given, promised or offered by or on behalf to the Contractor or his partner, agent or servant or anyone on his behalf, to any officer or employees of the RailTel, or to any person on his behalf in relation to obtaining or the execution of this or any other contract with the RailTel shall, in addition to any criminal liability which he may incur, subject the contractor to the rescission of the contract and all other contracts with the RailTel and to the payment of any loss or damage resulting from such decision and the RailTel shall be entitled to deduct the amounts so payable from any moneys due to the Contractor (s) under this contract or any other contracts with the RailTel.

18.2 The Contractor shall not lend or borrow from or have or enter into any monetary dealings or transactions either directly or indirectly with any employee of the RailTel and if he shall do so, the RailTel shall be entitled forthwith to rescind the contract and all other contracts with the RailTel. Any question or dispute as to the commission or any offence or compensation payable to the RailTel under this clause shall be settled by the Regional General Manager of RailTel, in such a manner as shall consider fit and sufficient and his decision shall be final and conclusive. In the event of rescission of the contract under this clause, the Contractor will not be paid any compensation whatsoever except payments for the work done up-to-date of rescission.

19. EXECUTION OF WORKS

19.1 **Contractor's understanding** – It is understood and agreed that the Contractor has, by careful examination, satisfied himself as to the nature and location of the work, the conformation of the ground, the character, quality and quantity of the materials to be encountered, the character of equipment and facilities needed preliminary to and during the progress of the works, the general and local conditions, the labour conditions prevailing therein and all other matters which can in any way affect the works under the contract.

19.2 **Commencement of works** – The Contractor shall commence the works within 15 days after the receipt by him of an order in writing to this effect from the RailTel and shall proceed with the same with due expedition and without delay.

19.3 **Accepted programme of work** – The Contractor who has been awarded the work shall as soon as possible but not later than 7 days from the date of receipt of the acceptance letter in respect of contracts with initial completion period of one year or less or not later than 15 days for other contracts have to submit the detailed programme of work indicating the time schedule of various items of works in the form of Bar Chart/PERT/CPM. He shall also submit the details of organization (in terms of labour and supervisors) plant and machinery that he intends to utilize (from time to time) for execution of the work within stipulated date of completion. The programme of work amended as necessary by discussions with the Engineer, shall be treated as the agreed programme of the work for the purpose of this contract and the contractor shall and endeavor to fulfill this programme of work. The progress of work will be watched accordingly in the liquidated damages will be with reference to the overall completion date. Nothing stated herein shall preclude

the contractor in achieving earlier completion of item or whole of the works than indicated in the programme.

19.4 **Setting out of works** – The Contractor shall be responsible for the correct setting out of all works in relation to original reference at his cost. The Contractor shall execute the work true to specifications, drawings, plans and dimensions as mentioned in the contract document and as directed by the Engineer's representative and shall check these at frequent intervals. The Contractor shall provide all facilities like labour and instruments and shall cooperate with the Engineer's representative at all time, during the progress of the works. Any error shall appear or arise in any part of the work, the Contractor, on being required so to do by the Engineer's representative shall, at his own rectify such errors, to the satisfaction of the Engineer's representative. Such checking shall not absolve the Contractor of his own responsibility of maintaining accuracy in the work.

20 **Compliance to Engineer's Instructions**

20.1 The Engineer shall direct the order in which the several parts of the works shall be executed and the Contractor shall execute without delay all orders given by the Engineer from time to time but the Contractor shall not be relieved thereby from responsibility for the due performance of the works in all respects.

20.2 **Alterations to be authorized** – No alterations in or additions to or omissions or abandonment of any part of the works shall be deemed authorized, except under instructions from the Engineer, and the Contractor shall be responsible to obtain such instructions in each and every case in writing from the Engineer.

20.3 **Extra Works** – Should works over and above those included in the contract require to be executed at the site, the contractor shall have no right to be entrusted with the execution of such works, which may be carried out by another contractor or contractors or by other Mean at the option of the RailTel.

20.4 **Separate Contracts in connection with works** – The RailTel shall have the right to let other contracts in connection with the works. The Contractor shall afford other contractors reasonable opportunity for the storage of their materials and the execution of their works and shall properly connect and coordinate his work with theirs. If any part of the Contractor's work depends for proper execution or result upon the work of another contractor(s) the Contractor shall inspect and promptly report to the Engineer any defects in such works that render it unsuitable for such proper execution and results. The Contractor failure so to inspect and report shall constitute an acceptance of the other contractor's work as fit and proper for the reception of his work, except as to defects which may develop in the other contractor's work after the execution of his work.

21. **Instructions of Engineer's Representative** – Any instructions or approval given by the Engineer's representative to Contractor in connection with the works shall bind the Contractor as though it had been given by the Engineer provided always as follows: -

21.1 Failure of the Engineer's representative to disapprove any work or materials shall not prejudice the power of the Engineer thereafter to disapprove such work or material and to order the removal or breaking up thereof.

- 21.2 If the Contractor shall be dissatisfied by reason of any decision of the Engineer's representative he shall be entitled to refer the matter to the Engineer who shall there-upon confirm or vary such decision.
22. **Adherence to specifications and drawings**
- 22.1 The whole of the works shall be executed in perfect conformity with the specifications and drawings of the contract. If the Contractor performs any works in a manner contrary to the specifications or drawings or any of them and without such reference to the Engineer, he shall bear all the costs arising or ensuring there-from and shall be responsible for all loss to the RailTel.
- 22.2.1 **Drawings and specifications on the works** – The contractor shall keep one copy of Drawings and specifications at the site, in good order, and such contract documents as may be necessary, available to the Engineer or the Engineer's Representative.
- 22.2.2 The supply of equipment and materials shall include supply of one set of printed documents from original equipment manufacturers with each equipment as given in technical supplement.
- 22.3 **Ownership of Drawings and Specifications** – All drawings and Specifications and copies thereof furnished by the RailTel to the Contractor are deemed to be the property of the RailTel. They shall not be used another works and with the exception of the signed contract set, shall be returned by the Contractor to the RailTel on completion of the work or termination of the Contract.
- 22.4 **Compliance with Contractor's request for details** – The Engineer shall furnish with reasonable promptness, after receipt by him of the Contractor's request for the same, additional instructions by means of drawings or otherwise, necessary for the proper execution of the works or any part thereof. All such drawings and instructions shall be consistent with the Contract Documents and reasonably inferable there from.
- 22.5 **Meaning and Intent of specification and drawings** – If any ambiguity arises as to the meaning and intent of any portion of the Specifications and Drawings or as to execution or quality of any work or material, or as to the measurements of the works the decision of the Engineer thereon shall be final subject to the appeal (within 7 days of such decision being intimated to the Contractor) to the competent authority in RailTel who shall have the power correct any errors, omissions, or discrepancies in aforementioned items and whose decision in the matter in dispute or doubt shall be final and conclusive.
23. **Working during night** – The Contractor shall not carry out any work between sunset and sunrise without the previous permission of the Engineer.
23. **Damage to Railways/RailTel property or private life and property** – The Contractor shall be responsible for all risk to the works and for trespass and shall make good at his own expense all loss or damage whether to the works themselves or any other property of the Railways/RailTel or the lives, persons or property of others from whatsoever cause in connection with the works until they are taken over by the RailTel and this although all reasonable and proper precautions may have been taken by the Contractor, and in case the RailTel shall be called upon to make good any costs, loss or damages, or to pay any compensation, including that payable under the provisions of the Workmen's Compensation Act or any statutory amendments thereof to any person or persons sustaining damages as aforesaid by reason of any act, or any negligence or omissions on the part of the Contractor the amount of any costs or charges including costs and charges in connection with legal proceedings, which the RailTel may incur in reference thereto, shall be charged to the

Contractor. The RailTel shall have the power and right to pay or to defend or compromise any claim of threatened legal proceedings or in anticipation of legal proceedings being instituted consequent on the action or default of the Contractor, to take such steps as may be considered necessary or desirable to ward off or mitigate the effect of such proceedings, charging to

Contractor, as aforesaid, any sum or sums of money which may be paid and any expenses whether for reinstatement or otherwise which may be incurred and the propriety of any such payment, defense or compromise, and the incurring of any such expenses shall not be called in question by the Contractor.

25. **Sheds, Stores houses and Yards** – The Contractor shall at his own expense provide himself with sheds, storehouses and yards in such situations and in such numbers as in the opinion of the Engineer is requisite for carrying on the works and the Contractor shall keep at each such sheds, store houses and yards a sufficient quantity of materials and plant in stock as not to delay the carrying out of the works with due expedition and the Engineer and the Engineer’s representative shall have free access to the said sheds, store houses and yards at any time for the purpose of inspecting the stock of materials or plant so kept in hand, and any materials or plant which the Engineer may object to shall not be brought upon or used in the works, but shall be forthwith removed from the sheds, store houses or yards by the contractor. The Contractor shall at his own expenses provide and maintain suitable mortar mills, soaking vats or any other equipments necessary for the executive of the works.
26. **Provision of efficient and competent staff** – The Contractor shall place and keep on the works at all times efficient and competent staff to give the necessary directions to his workmen and to see that they execute their work in sound and proper manner and shall employ only such supervisors, workmen and labourers in or about the execution of any of these works as are careful and skilled in various trades and callings. The Contractor shall at once remove from the works any agents, permitted sub-contractor, supervisor, workman or labourer who shall be objected to by the Engineer and if and whenever required by the Engineer, he shall submit a correct return showing the names of all staff and workmen employed by him. In the event of the Engineer being of the opinion that the Contractor is not employing on the works a sufficient number of staff and workmen as is necessary for the proper completion of the works within the time prescribed, the Contractor shall forthwith on receiving intimation to this effect take on the additional number of staff and labour specified by the Engineer within seven days of being so required and failure on the part of the Contractor to comply with such instructions will entitle the RailTel to rescind the contract under Clause 62 of these conditions.
27. **Workmanship and Testing**
 - 27.1 The whole of the works and/or supply of materials specified and provided in the contract or that may be necessary to be done in order to form and complete any part thereof shall be executed in the best and most substantial workman like manner with materials of the best and most approved quality of their respective kinds, agreeable to the particulars contained in or implied by the specifications and as referred to in and represented by the drawings or in such other additional particulars. Instructions and drawings may be found requisite to be given during the carrying on of the works and to the entire satisfaction of the Engineer according to the instructions and directions, which the Contractors may from time to time receive from the Engineer. The materials may be subjected to tests by means of such machines, instruments and appliances as the Engineer may direct and wholly at the expense of the Contractor.
 - 27.2 **Removal of Improper work and materials** – The Engineer or the Engineer’s representative shall be entitled to order from time to time: -

- 27.2.1 The removal from the site within the time specified in the order of any materials, which in his opinion are not in accordance with the specifications or drawings.
- 27.2.2 The substitution of proper and suitable materials, and
- 27.2.3 The removal and proper re-execution, notwithstanding any previous tests thereof or “on account” payments therefore, of any work which in respect of materials or workmanship is not in his opinion in accordance with the specifications and in case of default on the part of the Contractor in carrying out such order the RailTel shall be entitled to rescind the contract under Clause 62 of these conditions.
28. **Facilities for Inspection:** - The Contractor shall afford the Engineer and the Engineer’s Representative every facility for entering in and upon every portion of the work at all hours for the purpose of inspection or otherwise and shall provide all labour, materials, instruments, appliances and things of every kinds required for the purpose and the Engineer and the Engineer’s representative shall at all time have free access to every part of the works and to all places at which materials for the work are stored or being prepared.
29. **Examination of work before covering up:** - The Contractor shall give two days notice to the Engineer or the Engineer’s Representative whenever any work or materials are intended to be covered up in the earth, in bodies or walls or otherwise to be placed beyond the Reach of Measurements in order that the work may be inspected or that correct dimension may be taken before being so covered, placed beyond the reach of measurement in default whereof, the same shall at the option of the Engineer or the Engineer’s Representative be uncovered and measured at the contractor’s expense or no allowance shall be made for such work or materials.
30. **Temporary works:** - All Temporary works necessary for the proper execution of the works shall be provided and maintained by the Contractor and subject to the consent of the Engineer, shall be removed by him at his expenses when they are no longer required and in such manner as the Engineer shall direct. In the event of failure on the part of the Contractor to remove the temporary works, the Engineer will cause them to be removed and cost as increased by supervision and other incidental charge shall be recovered from the Contractor. If temporary huts are provided by the Contractor on the Railway land for labour engaged by him and the work is completed but the contractor’s labour refused to vacate and have to be removed by the RailTel, necessary expenses incurred by the RailTel in connection therewith shall be borne by the Contractor.
31. **Contractor to supply water for works**
- 31.1 Unless otherwise provided in the contract, the contractor shall be responsible for arrangements to obtain supply of water for the works.
- 31.2 Water supply from the Railway system
- 31.3 Water supply by Railway Transport: Deleted
- 31.4 Contractor to arrange supply of Electric power for works
- 31.4.1 Unless otherwise provided in the contract, the contractor shall be responsible for arrangements to obtain supply of Electric Power for the works.
- 31.4.2 **Electric supply from the Railway system** – The RailTel may supply to the Contractor part or whole of the electric power wherever available and possible, required for execution of works from the Railway’s existing electric supply systems at or near the site of works on specified terms and

conditions and such charges as shall be determined by the RailTel and payable by the contractor provided the cost of arranging necessary connection to the Railway's Electric supply systems, and laying of underground/overhead conducts circuit protection, electric power meters, transmission

structure, shall be borne by the Contractor and that the contractor shall not be entitled to any compensation for interruption or failure of the Electric supply system.

32. **Property in material and Plants:** Deleted
33. **Tools, Plant and Materials Supplied by the RailTel.**
- 33.1 The Contractor shall take all responsible care of all tools, plants and materials or other property whether of a like description or not belonging to the RailTel and committed to his charge for the purpose of the works and shall be responsible for all damage or loss caused by him, his agents permitted sub-contractor or his workmen or others while they are in his charge. The Contractor shall sign accountable receipts for tools, plants and materials made over to him by the Engineer and on completion of the works shall handover the unused balance of the same to the Engineer in good order and repair, fair wear and tear excepted and shall be responsible for any failure to account for the same or any damage done thereto.
- 33.2 **Hire of RailTel's Plant:** Deleted.
34. **Precaution during progress of work:**
- 34.1 During the execution of works, unless otherwise specified the Contractor shall at his own cost provide the materials for and execute all shoring, timbering and strutting works as is necessary for the stability and safety of all structures, excavations and works and shall ensure that no damage, injury, loss is caused or likely to be caused to any person or property.
- 34.2 **Roads and watercourses:** Existing roads or watercourses shall not be blocked, cut through, altered, diverted or obstructed in any way by the Contractor, except with the permission of the Engineer. All compensations claimed for any authorized closure, or his agent or his staff shall be recoverable from the Contractor by deduction from any sums which may become due to him in terms of contract or otherwise according to law.
- 34.3 **Provision of access to premises:** During progress of work in any street or thoroughfare, the Contractor shall make adequate provision of the passage of traffic, for securing safe access to all premises approached from such street or thoroughfare and for any drainage, water supply or meant for lightning which may be interrupted by reason of the execution of the works and shall react and maintain at his own cost barriers, lights and other safeguards as prescribed by the Engineer, for the regulation of the traffic, and provide watchmen necessary to prevent accidents. The works shall in such cases be executed night and day if so ordered by the Engineer and with such vigour so that the traffic way be impeded for as short a time as possible.
- 34.4 **Safety of Public:** The Contractor shall be responsible to take all precautions to ensure the safety of the public or Railway/RailTel's property and shall post such look out men as may in the opinion of the Engineer be required to comply with regulations pertaining to the work.
35. **Use of Explosives:** Explosive shall not be used on the works or on the site by the Contractor without the permission of the Engineer and then only in the manner and to the extent to which such permission is given. Where explosives are required for the works, the same shall be stored in a special magazine to be provided by and at the cost of the Contractor in accordance with the

Explosive Rules. The Contractor shall obtain the necessary license for the storage and the use of explosives and all operations in which or for which explosives are employed shall be at the sole risk and responsibility of the Contractor and the Contractor shall indemnify the Railway/RailTel in respect thereof.

36. **Suspension of works**

36.1 The Contractor shall on the order of Engineer suspend the progress of the works or any part thereof for such time or times and in such manner as the Engineer may consider necessary and shall during such suspension properly protect and secure the work so far as is necessary in the opinion of the Engineer. If such suspension is: -

- (a) Provided for in the contract, or
- (b) Necessary for the proper execution of the works or by the reason of weather conditions or by some default on the part of the Contractor, and or
- (c) Necessary for the safety of the works or any part thereof.

36.2 The Contractor shall not be entitled to the extra costs, if any, incurred by him during the period of suspension of the works; but in the event of any suspension ordered by the Engineer for reasons other than aforementioned and when each such period of suspension exceeds 14 days, the Contractor shall be entitled to such extension of time for completion of the works as the engineer may consider proper having regard to the period or periods of such suspensions and to such compensations as the Engineer may consider reasonable in respect of salaries or wages paid by the Contractor to his employees during the periods of such suspensions.

36.3 **Suspension lasting more than 3 months** – If the progress of the works or any part thereof is suspended on the order of the Engineer for more than three months at a time, the Contractor may serve a written notice on the Engineer requiring permission within 15 days from the receipt thereof to proceed with the works or that part thereof in regard to which progress is suspended and if such permission is not granted within that time the Contractor by further written notice so served may, but is not bound to, elect to treat the suspension where it affects part only of the works as an omission of such part or where it affects the whole of the works, as an abandonment of the contract by the RailTel.

37. **Rates for items of works** – The rates entered in the accepted Schedule of Rates of the Contract are intended to provide for works duly and properly completed in accordance with the general and special conditions of the contract and the specifications and drawings together with such enlargements, extensions, diminutions, reductions, alterations or additions as may be ordered in terms of Clause 42 of these conditions and without prejudice to the generality thereof and shall be deemed to include and cover superintendence and labour, supply including full freight of materials, stores, tools and all apparatus and plant required on the works, except such tools, plant or materials as may be specified in the contract to be supplied to the Contractor by the RailTel, the erection, maintenance and removal of all temporary works and buildings, all arrangements for the safety of the public or of employees during the execution of works, all sanitary and medical arrangements for labour camps as may be prescribed by the RailTel, the setting of all work and of the construction, repair and upkeep of all center lines, bench marks and level pegs thereon, site clearance, all fees, duties, royalties, rent and compensation to owners for surface damage or taxes and impositions payable to local authorities in respect of land, structures and all material supplied for the work or other duties or expenses for which the Contractor may become liable or may be put to under any provision of law for the purpose of or in connection with the execution of the contract, and all such other incidental charges or contingencies as may have been specially provided for in the specifications.

38. Demurrage and wharfage dues

38.1 Demurrage charges calculated in accordance with the scale in force for the time being on the RailTel and incurred by the Contractor failing to load or unload any goods or materials within the time allowed by RailTel for loadings as also wharfage charges, of materials not removed in time as also charges due on consignments booked by or to him shall be paid by the Contractor, failing which such charges shall be debited to the Contractor's account in the hands of the RailTel and shall be deducted from any sums which may become due to him in terms of the contracts.

39. Rates for extra items of works

39.1 Any item of work carried out by the Contractor on the instructions of the Engineer which is not included in the accepted schedule of rates shall be executed at the rates set forth in the "Schedule of Rates" modified by the tender percentage and such items are not contained in the latter, at the rate agreed upon between the Engineer and the Contractor before the execution of such items of work and the contractor shall be bound to notify the Engineer at least seven days before the necessity arises for the execution of such items of works that the accepted schedule of rates does not include rate or rates for the extra work involved. The rates payable for such items shall be decided at the meeting to be held between the Engineer and Contractor, in as short a period as possible after the need for the special item has come to the notice. In case the Contractor fails to attend the meeting after being notified to do so or in the event of no settlement being arrived at, the RailTel shall be entitled to execute the extra works by other Means and the contractor shall have no claim for loss or damage that may result from such procedure.

39.2 Provided that if the Contractor commences work or incurs any expenditure in regard thereto before the rates as determined and agreed upon as lastly hereunto fore mentioned, then and in such a case the Contractor shall only be entitled to be paid in respect of the work carried out or expenditure incurred by him prior to the date of determination of the rates as aforesaid according to the rates as shall be fixed by the Engineer. However if the contractor is not satisfied with the decision of the Engineer in this respect he may appeal to the competent authority of RailTel within 30 days of getting the decision of the Engineer, supported by analysis of the rates claimed. The competent authority of RailTel's decision after hearing both the parties in the matter would be final and binding on the Contractor.

40. Handing over of works:

40.1 The Contractor shall be bound to hand over the works executed under the contract to the RailTel complete in all respect to the satisfaction of the Engineer. The Engineer shall determine the date on which the work is considered to have been completed, in support of which his certificate shall be regarded as sufficient evidence for all purposes. The engineer shall determine from time to time, the date on which any particular section of the work shall have been completed, and the contractor and the contractor shall be bound to observe any such determination of the Engineer.

40.2 **Clearance of Site on Completion:** On completion of the works the Contractor shall clear away and remove from the site all constructional plant, surplus materials, rubbish and temporary works of every kind and leave the whole of the site and works clean and in a workman like condition to the satisfaction of the Engineer. No final payment in settlement of the accounts for the work shall be paid, held to be due or shall be made to the contractor till, in addition to any other condition necessary for such final payment, site clearance shall have been effected by him, and such clearance may be made by the Engineer at the expense of the Contractor in the event of his failure to comply with this provision within 7 days after receiving notice to that effect. Should it become necessary for the Engineer to have the site cleared at the expense of the Contractor, the RailTel

shall not be held liable for any loss or damage to such of the Contractor's property as may be on the site and due to such removal there from which removal may be effected by Mean of public sales of such materials and property or in such a way as deemed fit and convenient to the Engineer.

VARIATIONS IN EXTENT OF CONTRACT

41. **Modification to Contract to be in writing** – In the event of any of the provisions of the Contract requiring to be modified after the contract documents have been signed, the modifications shall be made in writing and signed by the RailTel and the Contractor, and no work shall proceed under such modifications until this has been done. Any verbal or written arrangement abandoning, modifying, extending, reducing or supplementing the Contract or any of the terms thereof shall be deemed conditional and shall not be binding on the RailTel unless and until the same is incorporated in a formal instrument and signed by the RailTel and the Contractor and till then the RailTel shall have the right to repudiate such arrangement.
42. **Powers of Modification to Contract**
- 42.1 The Engineer on behalf of the RailTel shall be entitled by order in writing to enlarge or extend, diminish or reduce the works or make any alterations in their design, character, position, site quantities, dimensions or in the method of their execution or in the combination and use of materials for the execution thereof or to order any additional work to be done or any works not to be done and the Contractor will not be entitled to any compensation for any increase / reduction in the quantities of work but will be paid only for the actual amount of work done and for approved materials supplied against a specific order.
- 42.2.1 Unless otherwise specified in the special conditions of the contract, the accepted variation in quantity for each individual item of the contract would be up to $\pm 25\%$ of the quantity originally contracted. The contractor shall be bound to carry out the work at the agreed rates and shall not be entitled to any claim or any compensation, whatsoever upto the limit of $\pm 25\%$ variation in quantity of individual items of works.
- 42.3 **Valuation of Variations** – The enlargements, extensions, diminution, reduction, alterations or additions referred to in sub-clause (2) of this clause shall in no degree affect the validity of the contract but shall be performed by the Contractor as provided therein and be subject to the same conditions, stipulations and obligations as if they had been originally and expressly included and provided for in the specifications and drawings and the amounts to be paid therefore shall be calculated in accordance with the accepted schedule of rates. Any extra items/quantities of work falling outside the purview of the provisions of sub-clause (2) above shall be paid for at the rates determined under clause 39 of these conditions.

CLAIMS

43. **Monthly Statement of Claims**
- 43.1 The contractor shall prepare and furnish to the Engineer once in every month an account giving full and detailed particulars of all claims for any additional expenses to which the Contractor may consider himself entitled to and of all extra or additional works ordered by the Engineer which he has executed during the preceding month and no claim for payment for and such work will be considered which has not been included in such particulars.

- 43.2 **Signing of “No Claim” Certificate** – The Contractor shall not be entitled to make any claim whatsoever against the RailTel under or by virtue of or arising out of this contract, nor shall the

RailTel entertain or consider any such claim, if made by the Contractor, after he shall have signed a ‘No Claim’ certificate in favour of the RailTel, in such form as shall be required by the RailTel, after the works are finally measured up. The Contractor shall be debarred from disputing the correctness of the items covered by “No Claim Certificate” or demanding a preference to arbitration in respect thereof.

MEASUREMENTS, CERTIFICATES AND PAYMENTS

44. Qualities in schedule annexed to Contract- The quantities set out in the accepted schedule of rates with items of works quantified are the estimated quantities of the works and they shall not be taken as the actual and correct quantities of the works to be executed by the Contractor in fulfillments of his obligations under the contract.

45. **Measurements of Works:** The Contractor shall be paid for the works at the rates in the accepted schedule of rates and for extra works at rates determined under Clause 39 of these conditions on the measurements taken by the Engineer or the Engineer’s representative in accordance with the rules prescribed for the purpose by the RailTel. The quantities for items the unit of which in the accepted schedule of rates is 100 or 1000 shall be calculated to the nearest whole number, any fraction below half being dropped and half and above being taken as one; for item the unit of which in the accepted schedule of rates is single, the quantities shall be calculated to places of decimals. Such measurements will be taken of the work in progress from time to time and at such intervals as in the opinion of the Engineer shall be proper having regard to the progress of works. The date and time on which “on account” or final measurements are to be made shall be communicated to the Contractor who shall be present at the site and shall sign the results of the measurements (which shall also be signed by the Engineer or the Engineer’s representative) recorded in the official measurements book as an acknowledgement of his acceptance of the accuracy of the measurements. Failing the Contractor’s attendance the work may be measured up in his absence and such measurements shall, notwithstanding such absence, be binding upon the Contractor whether or not he shall have signed the measurement book provided always that any objection made by him to measurement shall be duly investigated and considered in the manner set out below:

- (a) It shall be open to the Contractor to take specific objection to any recorded measurements or Classification on any ground within seven days of the date of such measurements. Any re-measurement taken by the Engineer or the Engineer’s representative in the presence of the Contractor or in his absence after due notice has been given to him in consequences of objection made by the contractor shall be final and binding on the Contractor and no claim whatsoever shall thereafter be entertained regarding the accuracy and classification of the measurement.
- (b) If an objection raised by the Contractor is found by the Engineer to be incorrect the Contractor shall be liable to pay the actual expenses incurred in measurements.

46. **“On-Account” Payments**

- 46.1 The Contractor shall be entitled to be paid from time to time by way of “On Account” payment only for such works as in the opinion of the Engineer he has executed in terms of the contract. All payment due on the Engineer’s or the Engineer’s Representatives certificate of measurements shall be subject to any deduction which may be made under these presents and shall further be subject to, unless otherwise required by Clause 16 of these conditions a retentions of 10% by way of security

deposits, until the amount of security deposit by way of retained earnest money and such retentions shall amount to 10% of the total value of the contract provided always that the Engineer may by any certificate make any correction or modification in any previous certificate which shall have

been issued by him and that the Engineer may withhold any certificate if the works or any part thereof are not being carried out to this satisfactions.

46.2 **Rounding off amounts:** The total amount due on the certificate shall be rounded off to the nearest rupee i.e. sums less than 50 paise shall be omitted and sums of 50 paise and more upto Rs. 1/- will be reckoned as Rs. 1/-.

46.3 **On-Account Payments not prejudicial to final settlements:**

“On Account” payments made to the Contractor shall be without prejudice to the final making up of the accounts (except where measurement are specifically noted in the Measurement Book as “Final Measurements” and as such have been signed by the Contractor) and shall in no respect be considered or used as evidence of any facts stated in or to be inferred from such account not of any particular quantity of work having been executed not of the manner of its execution being satisfactory.

46.4 **Manner of payment:**

Unless otherwise specified payments to the Contractor will be made by cheque but no cheque will be issued for any amount less than Rs. 100/-.

47. **Maintenance of works:** The Contractor shall at all times during the progress and continuance of the works and also for the period of maintenance specified in the tender form after the date of passing of the certificate of completion by the Engineer or any other earlier date subsequent to the completion of the works that may be fixed by the Engineer be responsible for and effectively maintain and uphold in good substantial sound and perfect conditions all and every part of the work and shall make good from time to time and at all times as often as the Engineer shall require, any damage or defect that may during the above period arise in or be discovered or be in any way connected with the works, provided that such damage or defect is not directly caused by errors in the contract documents, act of providence or insurrection or civil riot, and the Contractor shall be liable for and shall pay and make good to the RailTel or other persons legally entitled thereto whenever required by the Engineer so to do, all losses, damage, costs and expenses they or any of them may incur or be put or be liable or, by reason or in consequence of the operations of the Contractor or of his failure in any respect.

For this purpose the tenderer will submit their strategy for providing maintenance support including the staff who will be available along with the set of spares for attending to various faults/problems during maintenance period.

48. **Certificate of Completion of works**

48.1 As soon as in the opinion of the Engineer the works shall have been substantially completed and shall satisfactorily passed any final test or tests that may be prescribed, the Engineer shall issue a Certificate of the completion (Provisional Acceptance Certificate) in respect of the works and period of maintenance of the works shall commence from the date of such certificate provided that the Engineer may issue such a certificate with respect to any part of the works before the completion of the whole of the works or with respect to any substantial part of the works which has been both completed to the satisfaction of the Engineer and occupied or used by the RailTel and when any such certificate is given in respect of part of the works such part shall be considered as completed and the period of the maintenance of such part shall commence from the date of such certificate.

- 48.2 **Contractor not absolved by Provisional Completion Certificate (PAC):** The Certificate of completion in respect of the works referred to in sub-clause 48.1 of this clause shall not absolve the Contractor from his liability to make good any defect, imperfection, shrinkages or faults which may appear during the period of maintenance specified in the tender arising in the opinion of the Engineer from materials or workmanship not in accordance with the drawing or specifications or instructions of the Engineer, which defect, imperfections, shrinkages or faults shall upon the direction in writing of the Engineer, be amended and made good by the Contractor at his own cost; and in case of default on the part of Contractor the Engineer may employ, labour and material or appoint another Contractor to amend and make good such defect, imperfections, shrinkages and faults and all expenses consequent thereon and incidental thereto shall be borne by the Contractor and shall be recoverable from any moneys due to him under the contract.
49. **Approval only by Maintenance Certificate/Final Acceptance Certificate(FAC):** No certificate other than maintenance certificate referred to in Clause 50 of the conditions shall be deemed to constitute approval of any work or other matter in respect of which it is issued or shall be taken as an admission of the due performance of the contract or any part thereof or of the accuracy of any claim or demand made by the Contractor or of additional varied work having been ordered by the Engineer nor shall any other certificate conclude or prejudice any of the powers of the Engineers.
- 50 **Maintenance Certificate (FAC)**
- 50.1 The contract shall not be considered as completed until a maintenance certificate (Final Acceptance Certificate) shall have been signed by the Engineer stating that the works have been completed and maintained to his satisfaction. The maintenance certificate shall be given by the Engineer upon the expiration of the period of maintenance or as soon thereafter as any work ordered during such period pursuant to clause 48.2 of these conditions shall have been completed to the satisfaction of the Engineer and full effect shall be given to this Clause notwithstanding the taking possession of or using the works or any part thereof by RailTels.
- 50.2 **Cessation of RailTel's Liability:** The RailTel shall not be liable to the Contractor for any matter arising of or in connection with the contract of the execution of the works unless the Contractor shall have made a claim in writing in respect thereof before the issue of the Maintenance Certificate (FAC) under this clause.
- 50.3 **Unfulfilled obligations:** Notwithstanding the issue of the Maintenance Certificate the Contractor and (subject to clause 50.2) the RailTel shall remain liable for the fulfillment of any obligation incurred under the provision of the contract prior to the issue of the maintenance Certificate which remains unperformed at the time such certificate is issued and for the purposes of determining the nature and extent of any such obligations the contract shall be deemed to remain in force between the parties thereto.
51. **Final payment**
- 51.1 On the Engineer's certificate of completion in respect of the works an adjustment shall be made and the balance of account based on the Engineer or the Engineer's representative's on the accepted schedule or rates and for extra works on rates determined under Clause 39 of these conditions shall be paid to the Contractor subject always to any deduction which may be made under these presents and further subject to the Contractor having delivered to the Engineer either a full account in detail of all claims he may have on the RailTel in respect of the works or having delivered "No Claim" Certificate and the Engineer having after the receipt of such account given a certificate in writing that such claim are correct, that the whole of the works to be done under the provisions of the

Contracts have been completed, that they have been inspected by him since their completion and found to be in good and substantial order, that all properties, works and things removed, disturbed or injured in consequence of the works have been property replaced and made good and all expenses and demands incurred by or made upon the RailTel for or in the respect of damage or good and all expenses and demands incurred by or made upon the RailTel for or in the respect of damage or good and all expenses and demands incurred by or made upon the RailTel for or in the respect of damage or loss by from kin consequence of the works, have been satisfied agreeably and in conformity with the contract.

- 51.2 **Post payment Audit** – It is an agreed term of contract that the RailTel reserves to itself the right to carry out a post-payment audit and/or technical examination of the works and the final bill including all supporting vouchers, abstracts, etc., and to make a claim on the contractor for the refund of any excess amount paid to him if as a result of such examination any over-payment to him is discovered to have been made in respect of any work done or alleged to have been done by him under the contract.
- 51.3 **Refund of security deposit** – The total security deposit shall become due and shall be paid to the Contractor after the expiration of the warranty period and issue of the certificate of final acceptance of entire system, specified in the tender, provided that all the stipulations of the clause have been fulfilled by the Contractor and all claim and demands made against the RailTel for and in respect of damage or loss by, from or in consequence of the works have been finally satisfied, provided further that in the event of different maintenance periods having become applicable to different parts of the works pursuant to sub clause (i) of clause 48 of these condition, the expression “expiration of the period of warranty shall for the purpose of this clause, be deemed to mean the expiry of the latest of such periods”.
- 51.4 **Production of vouchers etc. by the Contractor**
- (i) For a contract of more than one crore of rupees, the contractor shall, whenever required, produce for examination by the Engineer any quotation, invoice, cost or other account, book of accounts, voucher, receipt letter, memorandum, paper of writing or any copy of or extract from any such document and also furnish information and returns verified in such manner as may be required in any way relating to the execution of this contract or relevant for verifying or ascertaining cost of execution of this contract (the decision of the Engineer on the question of relevancy of any documents, information or return being final and binding on the parties.) The contractor shall similarly produce vouchers, etc., if required to prove to the Engineer, that materials supplied by him, are in accordance with the specifications laid down in the contract.
- (ii) If any portion of the work in a contract of value more than one crore of rupees be carried out by the a sub-contractor or any subsidiary or allied firm or company (as per Clause 7 of the General Conditions of Contract), the Engineer shall have power to secure the book of such sub-contract or any subsidiary or allied firm or company, through the contractor, and such book shall be open to his inspection.
- (iii) The obligations imposed by sub clause (i) and (ii) above is without prejudice to the obligations of the contractor under any statute rules or orders binding on the contractor.
52. **Withholding and lien in respect of sums claimed** – Whenever any claim or claims for payment of a sum of money arises out of or under the contract against the contractor, the RailTel shall be entitled to withhold and also have a lien to retain such sum or sums in whole or in part from the security, if any, deposited by the contractor and for the purpose aforesaid, the RailTel shall be entitled to withhold the said security deposit or the security if any, furnished as the case may be and

also have a lien over the same pending finalization or adjudication of any such claim. In the event of the security being insufficient to cover the claimed amount or amounts or if no security has been taken from the contractor, the RailTel shall be entitled to withhold and have a lien to the extent of the such claimed amount or amounts referred to supra from any sum or sums found payable or

which at any time thereafter may become payable to the contractor under the same contract or any other contract with this or any other RailTel or any Department of the Central Government pending finalization or adjudication of any such claim.

It is an agreed term of the contract that the sum of money or moneys so withheld or retained under the lien referred to above, by the RailTels will be kept withheld or retained as such by the RailTel till the claim arising out of or under the contract is determined by the arbitrator (if the Contract is covered by the arbitration clause) or by the competent court as the case may be and that the contractor will have no claim for interest or damages whatsoever on any account in respect of such withholding or retention under the lien referred to supra and duly notified as such to the contractor. For the purpose of this clause, where the contractor is a partnership firm or a limited company, the RailTel shall be entitled to withhold and also have a lien to retain to-words such claimed amount or amounts in whole or in part from any sum found payable to any partner/limited company, as the case may be whether in his individual capacity or otherwise.

- 52.1 **Lien in respect of claims in Other Contracts** – Any sum of money due and payable to the contractor (Introducing the security deposit returnable to him) under the contract may be withheld or retained by way of lien by the RailTel, against any claim of this or any other RailTel or any other Department of the Central Government in respect of payment of a sum of money arising out of or under any other contract made by the contractor with this or any other Department of Central Government.

It is an agree term of the contract that the sum of money so withheld or retained under this clause by the RailTel will be kept withheld or retained as such by the RailTel till the Claim arising out of or under any other contract is either mutually settled or determined by arbitration, if the other contract is governed by arbitration clause or by the competent court as the case may be and contractor shall have no claim for interest or damages whatsoever on this account or on any other ground in respect of any sum of money withheld or retained under this clause and duly notified as such to the contractor.

53. **Signature on Receipts for Amounts** – Every receipt which may become payable or for any security which may become transferable to the Contractors under these presents, shall, if signed in the partnership name by any one of the partners of a Contractors firm be a good and sufficient discharge to the RailTel in respect of the moneys or security purported to be acknowledged thereby and in the event of death of any of the Contractor partners during the pendency of the contract it is hereby expressly agreed that every receipt by any one of the surviving Contractor partners shall if so signed as aforesaid be good and sufficient discharge as aforesaid provided that nothing in this clause contained shall be deemed to prejudice or effect any claim which the RailTel may hereafter have against the legal representative of any contractor partner so dying, for or in respect of any breach of any of the conditions of the contract, provided also, that nothing in this clause contained shall be deemed to prejudice or effect the respective rights or obligations of the Contractor partners and of the legal representative of any deceased Contractor partners interse.

LABOUR

54. **Wages to Labour** – The Contractor shall be responsible to ensure compliance with the provisions of the Minimum Wages Act, 1948 (hereinafter referred to as the “said Act”) and the Rules made

there-under in respect of any employees directly or through petty contractors or sub-contractors employed by him on road construction or in building operations or in stone breaking or stone crushing for the purpose of carrying out this contract. If in compliance with the terms of the contract, the contractor supplied any labour to be used wholly or partly under the direct orders and control of the RailTels whether in connection with any work being executed by the contractor or otherwise for the purpose of the RailTel such labour shall, for the purpose of this clause, still be deemed to be persons employed by the Contractor.

If any moneys shall as a result of any claim or any claim or application made under the said Act be directed to be paid by the RailTels, such moneys shall be deemed to be moneys payable to the RailTel by the Contractor and on failure by the Contractor to repay any moneys paid by it as aforesaid within seven days after the same shall have been demanded, the RailTels shall be entitled to recover the same from any moneys due or accruing to the contractor under this or any other Contractor with the RailTels.

- 54.1 **Apprentices Act** – The Contractor shall be responsible to ensure compliance with the provisions of the Apprentices Act 1961 and the Rules and Orders issued thereunder from time to time in respect of apprentices directly through petty contractors or sub-contractors employed by him for purpose of carrying out the contract.

If the Contractor directly or through petty contractor or sub-contractors fails to do so, his failure will be a breach of the contract and the RailTel may, in its discretion, rescind the contract. The contractor shall also be liable for any pecuniary liability arising on account of any violation of the provisions of the Act.

55. **Provisions of Payments of Wages Act** – The Contractor shall comply with the provisions of the Payment of Wages Act, 1936 and the rules made thereunder in respect of all employees directly or through petty contractors or sub-contractors employed by him in the works. If in compliance with the terms of the contract, the contractor directly or through petty contractors or sub-contractors shall supply any labour to be used wholly or partly under the direct orders and control of the Engineer whether in connection with the works to be executed hereunder or otherwise for the purpose of the Engineer such labour shall nevertheless be deemed to comprise persons employed by the contractor, and any moneys which may be ordered to be paid by the Engineer shall be deemed to be moneys payable by the Engineer on behalf of the contractor to repay such money to the RailTel deduct the same from any moneys due to the contractor in terms of the contract. The RailTel shall be entitled to deduct from any moneys due to the contractor (Whether under this contract or any other contract all moneys paid or payable by the RailTel by way of compensation of aforesaid or for costs of expenses in connection with any claim thereto and the decision of the Engineer upon any question arising out of the effect or force of this clause shall be final and binding upon the contractor.

55.1 Provision of Contract Labour (Regulation and Abolition) Act 1970

- (1) The Contractor shall comply with the provision of the Contract Labour (Regulation and Abolition) Act 1970 and the Contract Labour (Regulation and Abolition) Act, Central Rules 1971 as modified from time to time, whenever applicable and shall also indemnify the RailTel from and against any claims under the aforesaid Act and the Rules.
- (2) The Contractor shall obtain a valid licence under the aforesaid Act as modified from time to time before the commencement of the work and continue to have a valid licence until the completion of the work. Any failure to fulfill this requirement shall attract the penal provision of the Contract arising out of the resultant non-execution of the work.

- (3) The Contractor shall pay to the labour employed by him directly or through sub-contractors the wages as per provisions of the aforesaid Act and the Rules wherever applicable. The Contractor shall notwithstanding the provisions of the contract to the contrary, cause to be paid the wages to labour indirectly engaged on the work including any engaged by his sub-contractors in connection with the said work, as if the labour had been immediately employed by him.
 - (4) In respect of all labour directly or indirectly employed in the work for performance of the contractor's part of the contract the contractor shall comply with or cause to be complied with the provisions of the aforesaid Act and the Rules wherever applicable.
 - (5) In every case in which, by virtue of the provisions of the aforesaid Act or the Rules, the RailTel is obliged to pay any amount of wages to a workmen employed by the contractor or his sub-contractor in execution of the work or to incur any expenditure in providing welfare and health amenities required to be provided under the aforesaid Act and the Rules or to incur any expenditure in providing welfare and health amenities required to be provided under the aforesaid Act the Rules or to incur any expenditure on account of the contingent liability of the RailTel due to contractor's failure to fulfill his statutory obligations under the aforesaid Act or the Rules the RailTel will recover from the contractor, the amount of wages so paid or the amount of expenditure so incurred, and without prejudice to the rights of the RailTel under section 20, sub-section (2) and section 2 sub-section (4) of the aforesaid Act, the RailTel shall be at liberty to recover such amount or part thereof by deducting it from the security deposit and/or from any sum due by the RailTel to the contractor whether under the contract or otherwise. The RailTel shall not be bound to contest any claim made against it under sub-section (1) of section 20 and sub-section (4) of section 21 of the aforesaid Act except on the written request of the contractor and upon his giving to the RailTel full security for all costs for which the RailTel might become liable in contesting such claim. The decision of the RailTel regarding the amount actually recoverable from the contractor as stated above, shall be final and binding on the contractor.
56. **Reporting of Accidents to Labour** – The Contractor shall be responsible for the safety of all employees directly or through petty contractors or sub-contractors employed by him on the works and shall report serious accidents to any of them however and wherever occurring on the works to the Engineer or the Engineer's Representative and shall make every arrangement to render all possible assistance.
57. **Provisions of Workmen's Compensation Act** – In every case in which by virtue of the provision of Section 12 sub-section (1) of the Workmen's Compensation Act, 1923, RailTel is obliged to pay compensation to a workman directly or through the petty Contractor employed by the Contractor or sub-contractor in executing the work, RailTel will recover from the contractor the amount of the compensation so paid, and, without prejudice to the right of RailTel under Section 12 sub-section (2) of the said Act. RailTel shall be at liberty to recover such amount or any part thereof by deducting it from the security deposit or from any sum due by RailTel to the Contractor whether under these conditions or otherwise, RailTel shall not be bound to contest any claim made against it under Section 12, sub-section (1) of the said Act except on the written request of the Contractor and upon his giving to RailTel full security for all costs for which RailTel might become liable in consequence of contesting such claim.
- 57.1 **Provision of Mines Act** – Deleted

58. RailTel not to provide quarters for Contractor – No quarters shall be provided by the RailTel for the accommodation of the contractor or any of his staff employed on the work.

59 **Labour camps:**

- (1) The Contractor shall at his own expense make adequate arrangements for the housing, supply of drinking water and provision of latrines and urinals for his staff and workman directly or through the petty contractors or sub-contractors and for temporary crèche (Bal-Mandir) where 50 or more women are employed at a time. Suitable sites on RailTel land, if available, may be allotted to the Contractor for the erection of labour camps either free of charge or on such terms and conditions that may be prescribed by the RailTel. All camp sites shall be maintained in clean and sanitary conditions by the Contractor at his own cost.
- (2) **Compliance to Rules for Employment of Labour** – The Contractor(s) shall conform to all laws, bye-laws, rules and regulations for the time being in force pertaining to the employment of local or imported labour and shall take all necessary precautions to ensure and preserve the health and safety of all staff employed directly or through petty Contractors or sub-contractors on the works.
- (3) **Preservation of Peace** – The Contractor shall take requisite precautions and use his best endeavors to prevent any riotous or unlawful behavior by or amongst his workmen and others employed directly or through petty contractor or sub-contractors on the works and preserve the health and safety of all staff employed directly or through petty Contractors or sub-contractors on the works.
- (4) **Sanitary Arrangement** – The contractor shall obey all sanitary rules and carry out all sanitary measures that may time to time be prescribed by the RailTel Medical Authority and permit inspection of all sanitary arrangements at all times by the Engineer, the Engineer's Representative or the Medical Staff of the RailTel. Should the Contractor fail to make adequate sanitary arrangements, these will be provided by the RailTel and the cost therefore recovered from the contractor.
- (5) **Outbreak of Infectious Disease** – The Contractor shall remove from his camp such labour and their families as refuse protective inoculation and vaccination when called upon to do so by the Engineer or the Engineer's Representative on the advice of the Railway/RailTel Medical Authority. Should Cholera, Plague or other infectious disease break out, the Contractor shall burn the huts, beddings, clothes and other belongings of or used by the infected parties and promptly erect new huts on healthy sites as required by the engineer, failing which within the time specified in the Engineer's requisition, the work may be done by the RailTel and the cost therefore recovered from the Contractor.
- (6) **Treatment of Contractor's staff in Railway Hospitals** – Deleted
- (7) **Medical facilities at site** – The contractor shall provide medical facilities at the site as may be prescribed by the engineer on the advice of the medical authority in relation to the strength of the contractor's resident staff, and workmen.
- (8) **Use of Intoxicants** – The sale of ardent spirits or other intoxicating beverages upon the work or in any of the buildings, encampments or tenements owned, occupied by or within the control of the Contractor or any of his employees shall be forbidden and the Contractor shall exercise his influence and authority to the utmost extent to secure strict compliance with this condition.

- (9) **Non-employment of Female Labour** – The contractor shall see that the employment of female labour in cantonment areas, particularly in the neighborhood of soldier’s barracks, should be avoided as far as possible.
- 10) **Restrictions on the employment of retired Engineers of Railway services within two years of their Retirement** – The contractor shall not, if he is a retired government engineer of Gazetted rank, who has not completed two years from the date of retirement, in connection with his contract in any manner whatsoever without obtaining prior permission of the President and if the contractor is found to have contravened this provision, it will constitute a breach of contract and Administration will be entitled to terminate the contract of the contractor and forfeit his security deposit.
60. **Non-Employment of Labourers below the age of 15**
- (1) The Contractor shall not employ children below the age of 15 as labourers directly or through petty contractors or sub-contractors for the execution of work.
- (2) **Medical Certificate of Fitness for Labour** – It is agreed that the contractor shall not employ a person above 15 and below 19 years of age for the purpose of execution of work under this contract unless a medical certificate of fitness in the prescribed form granted to him by a certifying surgeon certifying that he is fit to work as an adult is obtained and kept in the custody of the contractor or a person nominated by him in this behalf and the person carries with him, while at work, a token giving a reference to such certificate. It is further agreed that the responsibility for having the adolescent examined medically at the time of appointment or periodically till he attains the age of 19 years shall devolve entirely on the contractor and all the expense to be incurred on this account shall be borne by him and no fee shall be charged from the adolescent or his parent for such medical examination.
- (3) **Period of Validity of Medical Fitness Certificate** – A certificate of fitness granted or renewed for the above said purposes shall be valid only for a period of one year at a time. The certifying surgeon shall revoke a certificate granted or renewed if in his opinion the holder of it is, no longer fit for work in the capacity stated therein. Where a certifying surgeon refuses to grant or renew a certificate or revoke a certificate, he shall, if so required by the person concerned, state his reasons in writing for doing so.
- (4) **Medical Re-examination of Labourer** – Where any official appointed in this behalf by the Ministry of Labour is of the opinion that any person employed in connection with the execution of any work under this contract in the age group 15-19 years is without a certificate of fitness or is having a certificate of fitness but no longer fit to work in the capacity stated in the certificate, he may serve on the Contractor, or on the person nominated by him in this regard, a notice requiring that such person shall be examined by a certifying surgeon and such person shall not, if the concerned official so directs, be employed or permitted to do any work under this contract unless he has been medically examined and certified that he has been granted a certificate of fitness or a fresh certificate or a fresh certificate of fitness, as the case may be.
61. **DETERMINATION OF CONTRACT**
- 61.1.1 **Right of RailTel to determine the contract:** The RailTel shall be entitled to determine and terminate the contract at any time, should in the RailTel’s opinion, the cessation of work becomes necessary owing to paucity of funds or from any other cause whatever, in which case the value of approved materials at site and of work done to date by the Contractor will

be paid for in full at the rate specified in the contract. Notice in writing from the RailTel of such determination and the reasons therefore shall be conclusive evidence thereof.

61.2 **Payment on determination of contract:** Should the contract be determined under sub-clause (1) of this clause and the Contractor claims payment for expenditure incurred by him in the expectation of completing the whole of the work, the RailTel shall admit and consider such claims as are deemed reasonable and are supported by vouchers to the satisfactions of the Engineer. The RailTel's decision on the necessity and propriety of such expenditure shall be final and conclusive.

61.3 The contractor shall have no claim to any payment of compensation or otherwise, howsoever on account of any profit or advantage which he might have derived from the execution of the work in full but which he did not derive in consequence of determination of contract.

62. **TERMINATION OF CONTRACT OWING TO DEFAULT OF CONTRACTOR:**

62.1 If the Contractor should:

- (i) Become bankrupt or insolvent, or
- (ii) Make an arrangement with or assignment in favour of his creditors, or
- (iii) Being a Company or Corporation, go into liquidation (other than voluntary) liquidation for the purpose of amalgamation or reconstruction, or
- (iv) Have an execution levied on his goods or property on the works, or assign the contract or any part thereof otherwise than as provided in clause-21 of SCC, or
- (v) Abandon the contract, or
- (vi) Persistently disregard the instructions of the RailTel's Engineer with regard to work, or
- (vii) Contravene any provision of the contract, or
- (viii) Fail to adhere to the agreed programme of work by a margin of 10% of the Stipulated period, or
- (ix) Fail to remove materials from the site or to pull down and replace the work after receiving from the Engineer's notice to the effect that the said materials or works have been condemned or rejected, or
- (x) Fail to take steps to employ competent or additional staff and labour as required under clause 7 of SCC (Chapter 4 Section-I) or
- (xi) Fail to afford the Engineer or Engineer's representative proper facilities for inspecting the works or any part thereof as required under clause 28, or
- (xii) Promise offer or give any bribe, commission, gift or advantage either himself or through his partner, agent or servant to any officer or employee of RailTel or any person on his or on their behalf in relation to the execution of this or any other contract with the RailTel,
- (xiii)(A) At any time after the tender relating to the contract has been signed and submitted by the contractor, being a partnership firm admit as one of its partners or employ under it or being an

incorporated company elect or nominate or allow to act as one of its directors or employ under it in any capacity whatsoever any retired engineer of the gazetted rank or any other retired gazetted officer working before his retirement, whether in the executive or administrative capacity, or whether holding any pensionable post or not, in the Engineering Department of the Railways for the time being owned and administered by the President of India before the expiry of two years from the date of retirement from the said service of such Engineer or Officer unless such Engineer or Officer has obtained permission from the President of India or any officer duly authorized by him in this behalf to become a partner or a director or to take employment under the contract as the case may be, or

B) Fail to give at time of submitting the said tender:-

- a) The correct information as to the date of retirement of such retired engineer or retired officer from the said service, or as to whether any such retired engineer or retired officer was under the employment of the contractor at the time of submitting the said tender, or
- a) the correct information as to such engineers or officers obtaining permission to take employment under the contractor, or
- b) being a partnership firm the correct information as to, whether any of its partners was such a retired engineer or retired officer, or
- c) being an incorporated company, the correct information as to, whether any of its directors was such a retired engineer or retired officer, or
- d) being such a retired engineer or retired officer suppress and not disclose at the time of submitting the said tender the fact of his being such a retired engineer or a retired officer or make at the time of submitting the said tender a wrong statement in relation to his obtaining permission to take the contract or if the contractor be a partnership firm or an incorporated company to be a partner or director of such firm or company as the case may be or to seek employment under the contractor.

Then and in any of these said clauses, the Engineer on behalf of the RailTel may serve the Contractor with a notice in writing to that effect and if the Contractor does not, within 7 days after the delivery to him of such notice, proceed to make good his default in so far as the same is capable of being made good and carry on the work or comply with such directions as aforesaid to the entire satisfaction of the Engineer, the RailTel shall be entitled after giving 48 hours notice in writing under the hand of the Engineer to rescind the contract as a whole or in part or parts (as may be specified in such notice) and adopt either or both the following courses: A final termination notice will be issued by RailTel after expiry of 48 hrs notice.

62.2 RIGHT OF RAILTEL AFTER TERMINATION OF CONTRACT OWING TO DEFAULT OF CONTRACTOR:

In the event of any or several of the courses, referred in clause 62.1 above, being adopted:

- (a) The Contractor shall have no claim to compensation for any loss sustained by him by reason of his having purchased or procured any materials or entered into any commitments or made any advances on account of or with a view to the execution of the works or the performance of the contract and Contractor shall not be entitled to recover or be paid any sum for any works thereto not actually performed under the contract, unless or until the Engineer shall have certified the

performance of such work and the value payable in respect thereof and the Contractor shall only be entitled to be paid the value so certified.

- (b) The Engineer or Engineer's Representative shall be entitled to take possession of any materials, tools, implements, machinery or buildings on the works or on the property on which these are being or ought to have been executed, and to retain the employ the same in the further execution of the works or any part thereof until the completion of the works without the Contractor being entitled to any compensation for the use and employment thereof or for wear and tear or destruction thereof.
 - (c) The Engineer shall, as soon as may be practicable after removal of the Contractor fix and determine expert or by or after reference to the parties or after such investigation or enquiries as he may consider fit to make or institute and shall certify what amount (if any) has at the time of termination of the contract been reasonably earned by or would reasonably accrue to the Contractor in respect of the work then actually done by him under the contract what was the value of any unused or partially used materials, any constructional plants and any temporary works upon the site. The legitimate amount due to the contractor after making necessary deductions and certified by the Engineer should be released expeditiously.
63. Matters finally determined by the RailTel: All disputes and differences of any kind whatsoever arising out of or in connection with the contract, whether during the progress of the work or after its completion and whether before or after the determination of the contract shall be referred by the contractor to the RailTel and the RailTel shall within 120 days receipt of the Contractor's representation make and notify decisions on all matters referred to by the contractor in writing provided that matters for which provision has been made in clause 8, 18, 22.5, 29, 43.2, 45(a), 55, 55.1(5), 57, 61.1, 61.2 and 62.1 of General Condition of Contract or in any clause of the Special Conditions of the Contract shall be deemed as 'excepted matters' and decisions of the RailTel's authority, thereon shall be final and binding on the contractor provided further that 'excepted matters' shall stand specifically excluded from the purview of the arbitration clause and not be referred to arbitration.

64. **SETTLEMENT OF DISPUTE AND ARBITRATION**

64.1 Arbitration with Private Parties.

- 64.1.1 Any dispute or difference whatsoever arising between the parties out of or relating to the construction, meaning, scope, operation or effect of this contract or the validity or the breach thereof shall be settled by a sole arbitrator in accordance with provisions contained in Arbitration and Conciliation Act, 1996 as amended and the award made in pursuance thereof shall be binding on the parties. The venue of such arbitration or proceedings thereof shall be Delhi.
- 64.1.2 All arbitration proceedings shall be conducted in English. Resources against any Arbitral award so rendered may be entered into court having jurisdiction or application may be made to such court for the order of enforcement as the case may be.
- 64.1.3 The Arbitral Tribunal shall consist of the sole Arbitrator if the value of claim is upto Rs. 10 lakhs. The arbitrator will be by the Managing Director of RailTel Corporation of India Limited. If the value of claim or amount under dispute is more than Rs. 10 lakhs, the matter shall be referred to the adjudication of arbitral council. Managing Director/ RailTel shall furnish a panel of three names to the contractor, out of which contractor will recommend one name to be his nominee and then Managing Director /RailTel shall appoint out of the panel one name as RailTel's nominee and these two arbitrators with mutual consent appoint a third arbitrator who shall act as deciding arbitrator.

The award of the Sole arbitrator or the Arbitral council, as the case may be, shall be final and binding on both the parties, i.e. Contractor and RailTel.

64.1.4 Each of the parties agree that notwithstanding that the matter may be referred to Arbitrator as provided herein, the parties shall nevertheless pending the resolution of the controversy or disagreement continue to fulfil their obligation under this Agreement so far as they are reasonably able to do so.

64.2 Arbitration with CPSE / Govt Department / Govt Organisation.

64.2.1 In the event of any dispute or difference relating to the interpretation and application of the provisions of the contracts, such dispute or difference shall be referred by either party for Arbitration to the sole Arbitrator in the Department of Public Enterprises to be nominated by the Secretary to the Government of India in-charge of the Department of Public Enterprises. The Arbitration and Conciliation Act, 1996 shall not be applicable to arbitration under this clause. The award of the Arbitrator shall be binding upon the parties to the dispute, provided, however, any party aggrieved by such award may make a further reference for setting aside or revision of the award to the Law Secretary, Department of Legal Affairs, Ministry of Law & Justice, Government of India. Upon such reference the dispute shall be decided by the Law Secretary or the Special Secretary/Additional Secretary when so authorized by the Law Secretary, whose decision shall bind the Parties finally and conclusively. The Parties to the dispute will share equally the cost of arbitration as intimated by the Arbitrator.



SECTION – I
CHAPTER- 4
SPECIAL CONDITIONS OF CONTRACT
(SCC)

I N D E X

Clause	Content
1.	Tender Document
2.	Agreement
3.	Contract performance Guarantee
4.	Contractor's Office & Stores depot
5.	Use of Railway Land
6.	Program of work.
7.	Competent Supervisors
8.	Not used
9.	Not used
10.	Test & Measuring Instruments, Special tools & Installation Material
11.	Stores to be supplied by contractor
12.	Supply of Technical Literatures, Documentation Drawings & Completion Plan etc.
13.	Spares
14.	Long term availability of spares & System support
15.	Quality assurance
16.	Not used
17.	Inspection of materials
18.	Inspection of works
19.	Quantum of work and variation in Quantities
20.	Not used
21.	Subletting and assignment

22. Execution of works
24. Not used
24. Maintenance of works
25. Clearance of site
26. Provisional Acceptance
27. Placing in Service & Maintenance Supervision
28. Final Acceptance
29. Warranty
30. Training
31. Infringement of Patents
32. License as per Govt. of India Contract Labour Act
33. Defaults and Delays
34. Loss Sustained Due to Default and Delay
35. Penalty for Delay in Completion
36. Extension of time
37. Contractors liabilities for Costs and Damages
38. Unit prices
39. Measurement of works
40. Terms of Payments
41. Final Payments
42. Final Settlement
43. Certificate for MODVAT BENEFITS on bills
44. Deductions from On Account Payment Bills
45. Taxes
46. Mobilization Advance
47. Insurance
48. Rights of RailTel
49. Responsibility of contractor in respect of local taxing etc.
50. Responsibility of contractor in respect of safety of man, Eqpt. etc.
51. Consequences of cancelation
52. Strike & Lock-outs
53. Guarantee
54. Rates of extra item



SECTION – I

Chapter- 4

SPECIAL CONDITIONS OF CONTRACT

1. TENDER DOCUMENTS

- 1.1 The goods and services required, bidding procedure and contract terms are prescribed in the tender documents. The set of tender documents issued for the purpose of bidding includes any addendum and corrigendum thereto.
- 1.2 If the Tender submitted by a Tenderer is accepted and the contract awarded to the Tenderer the various works coming under the purview of the contract shall be governed by tender documents mentioned above.
- 1.3 Any special conditions stated by the Tenderer in the covering letter submitted alongwith the tender shall be deemed to be a part of the Contract to such extent only as have been explicitly accepted by the RailTel.

2. AGREEMENT

The successful Tenderer shall **within 15** days after award of contract be bound to execute an agreement based on accepted rates and conditions, in such form as the RailTel may prescribe, and lodge the same with the RailTel together with the conditions of contract, specifications and Schedule of prices referred to therein duly completed. (Form No.3 of Section-I, Chapter-6).

3. CONTRACT PERFORMANCE GUARANTEE

- 3.1 On receipt of the Letter of Acceptance of Tender from the RailTel the successful Tenderer should give a Performance Guarantee in the form of irrevocable bank guarantee from State Bank of India/any Nationalized Bank or from any Scheduled Bank in the Form no. 4, amounting to 5% of the contract value.
- 3.2 The Performance Guarantee should be furnished by the successful contractor after letter of acceptance has been issued, but before signing of the agreement. The agreement should normally be signed within 15 days after issue of LOA and Performance Guarantee should also be submitted within this time limit. The instruments for Performance Guarantee should be valid for four months beyond the warranty period (Clause 29) of SCC.
- 3.3 Performance Guarantee shall be released after satisfactory completion of the work, maintenance period and on expiry of the warranty period and issue of the certificate of final acceptance of the entire system. The procedure for releasing should be same as for Security Deposit.
- 3.4 Wherever the contracts are rescinded, the security deposit should be forfeited and the Performance Guarantee shall be encashed and the balance work should be got done separately.
- 3.5 The balance work shall be got done independently without risk and cost of the original contractor.
- 3.6 The original contractor shall be debarred from participating in the tender for executing the balance work. If the failed contractor is a Joint Venture (JV) of or a partnership firm, then every

member/partner of such a firm would be debarred from participating in the tender for the balance work either in his/her individual capacity or as a partner of any other JV/partnership firm.

4. CONTRACTOR'S OFFICE & STORES DEPOT

The Contractor shall within ten days of issue of Letter of Acceptance (LOA) of tender establish an office and store depot at a convenient place for receiving and storing equipments and materials and progressing field work expeditiously in consultation and with the approval of the purchaser's Engineer. He shall intimate the purchaser's Engineer address thereof to which all correspondence should be sent. Any communication sent to the contractor by post at his said address shall be deemed to have reached the contractor duly and in time. Important documents shall be sent by Registered post.

5. USE OF RAILWAY LAND - Deleted

6. PROGRAMME OF WORK

6.1 The Contractor shall have necessary resources to execute the work so that the entire work is completed within a period as mentioned in the preamble from the date of issue of Letter of Acceptance of the tender. He shall also have necessary resources to take up the work simultaneously at more than one independent places in order to expedite the completion of work.

6.2 The Contractor who has been awarded the work shall as soon as possible but not later than 7 days from the date of receipt of the acceptance letter in respect of contracts with initial completion period of one year or less or not later than 15 days for other contracts have to submit the detailed programme of work indicating the time schedule of various items of works in the form of Bar Chart/PERT/CPM. He shall also submit the details of organization (in terms of labour and supervisors) plant and machinery that he intends to utilize (from time to time) for execution of the work within stipulated date of completion. The programme of work amended as necessary by discussions with the Engineer, shall be treated as the agreed programme of the work for the purpose of this contract and the contractor shall and endeavor to fulfill this programme of work. The progress of work will be watched accordingly in the liquidated damages will be with reference to the overall completion date. Nothing stated herein shall preclude the contractor in achieving earlier completion of item or whole of the works than indicated in the programme

6.3 The Contractor shall be held responsible for the execution of the work according to the Programme given above in full compliance of the various clauses of the Technical specifications, instructions/ drawings etc. Failure to comply with any of these will be dealt with as per provision laid down in Conditions of Tendering.

6.4 Approach roads, where ever available can be used for carting materials. While RailTel may facilitate the contractor for getting approval from the Railways, if required, for carting the material to the site, the responsibility for ensuring that the material reaches the site in time, lies entirely with the contractor. The contractor has to bear the necessary expenses for carting the material to the site and he shall also arrange for the necessary Road permits in case of carriage of material by Road.

6.5 The contractor will programme his work in such a manner so as not to interfere in the working and movement of trains.

7. COMPETENT SUPERVISORS

7.1 The Contractor shall place and keep prescribed number of competent representatives / Supervisors / Engineers as his representative on the works who will be authorized to receive and acknowledge materials issued by the RailTel and take all orders issued by the RailTel. The said representatives shall be present at site during working hours and any written orders or instructions which the purchaser's Engineer may give to the said representatives of the contractor shall be deemed to have been duly given or communicated to the contractor.

8. Not used

9. Not used

10. **TEST & MEASURING INSTRUMENTS AND SPECIAL TOOLS ETC.**

Special tools & instruments required for installation and commissioning of the work as detailed in preamble shall be arranged by contractor at his own cost.

All tests and measuring instruments and other arrangements required for carrying out all the acceptance tests etc as detailed in preamble shall be provided by the contractor at his own cost.

11. **STORES TO BE SUPPLIED BY CONTRACTOR**

All materials required for the execution of the contract shall be arranged and supplied by the Contractor so as to realize the end objective. The supply of equipments and materials shall also include required installation and other materials and documents etc which may not be specifically mentioned herein but which are necessary for completing the work in all respects.

12. **SUPPLY OF TECHNICAL LITERATURES, DOCUMENTATION, DRAWINGS, INSTRUCTION BOOK & COMPLETION PLANS ETC.**

12.1 The supply of equipment and materials shall include supply of one set of printed documents from original equipment manufacturers with each equipment as given in technical supplement.

12.2 Except where printed documents are supplied with each equipment by original equipment manufacturer, all other documentation and information as mentioned in the technical specifications shall be prepared using CAD or any other software package duly approved by Engineer. In addition to what is specified in the technical specifications, two complete hard sets of documents shall also be supplied for ready use duly bounded in good plastic folders.

13. **DELETED**

14. **DELETED**

15. **QUALITY ASSURANCE**

15.1 In the event of RailTel waving off the inspection, the quality assurance department of the manufacturer shall carry out all the tests as per the specification and issue a certificate indicating clearly the test results and the adherence to the technical specifications. This is without prejudice to the purchaser's right to accept or reject the supplies if not found in conformity to its requirement.

16. Not used

17. **INSPECTION OF MATERIALS**

- 17.1 Equipment of all types as per SOR shall be subjected to Acceptance test by RailTel or their authorized representative. The materials to be supplied by the tenderer as per RDSO specifications/Drawings shall be procured from RDSO approved firms only and shall be supplied inspected by RDSO. RDSO specification mentioned shall be with the latest alteration/amendment, if any.
- 17.2 All equipments materials fittings and components will be subject to inspection by the purchaser or his representative at the manufacturer's factory/tenderer works before dispatch and no materials shall be dispatched until these are inspected and/or approved. The materials may also be inspected by the purchaser or his representative again at the contractor's depot.
- 17.3 All materials shall be procured from the manufacturers of repute/their authorized dealers. Such materials are to be accepted by the Engineer. The Contractor may be required to produce test certificate from the manufacturer wherever called for by the Engineer.
- 17.4 The cost of equipment and materials, all tests and/or analysis performed for inspection shall be borne by the Contractor.
- 17.5 The inspection charges, if any, payable to the purchaser's representative for carrying out the inspection shall be borne by the purchaser.

18. INSPECTION OF WORKS

The Engineer or his representative may inspect and test the various portions of the work at all stages and shall have full power to reject all or any portion of the work that he may consider to be defective or inferior in quality of materials, workmanship or design in comparison to what is called for in the specification. In the event of rejection of any work already executed and not in accordance with specification as in this tender and/or as determined by the Engineer or which the Contractor has been apprised, the Contractor shall carry out alterations/ replacements to such works to the satisfaction of the Engineer for which no additional expenses will be borne by the RailTel.

19. QUANTUM OF WORK AND VARIATION IN QUANTITIES

- 19.1 The quantities quoted in the Schedule are not firm and may be varied at the time of awarding and during the currency of the contract.
- 19.2 The quantity indicated in the Schedule of Requirements is the estimated quantities in respect of the work and may change depending on the detailed survey/system design. On this and other developments, the purchaser may exercise the option of increase / decrease of the quantity of items of Schedule of Requirements by plus 25% (Twenty five percent) or minus 25% (twenty five percent) of the value of the contract respectively either within the scope of the work.
- 19.3 The Contract value may vary within +25% / -25% of the grand total of Schedule of Requirements as included in the Letter of Acceptance to tenderer, In case of variation in quantities the contractor shall be bound to carry out the work at the rates agreed in the schedule up to the limit of +25% / -25% variation in the value of contract and shall not be entitled to any claim or any compensation whatsoever.
- 19.4 Quantity variation beyond 25% will also be within the scope of the agreement. However, for the variation beyond +25% (a) for the first 15% increase in the quantity beyond 25% of agreemental value, the rates will have a reduction of 2% in the incremental value of the agreement. (b) and for the next

10% increase in the quantity, the rates will have an additional reduction of 2% in further incremental value of the agreement.

- 19.5 In case the execution of quantity is required to exceed +50% of the overall agreemental value, the rates shall be negotiated.
- 19.6 Variation in quantities with in the sections tendered must be accepted by Tenderer as per clauses 19.1 to 19.5 above. However variation for new sections if offered by purchaser may be accepted by the tenderer at their choice.

20. Not used

21. **SUBLETTING AND ASSIGNMENT**

- 21.1 The contractor may enter into contract with suppliers for supply of materials under this contract.
- 21.2 The contractor may subcontract the execution of part(s) of the project with the prior approval of RailTel under following conditions-
- (i) The permitted subletting of work by the contractor shall not establish any contractual relationship between the sub-contractor and the RailTel and shall not relieve the contractor of any responsibility under the contract.
 - (ii) The contractor shall arrange for effective supervision of sub contractor's work and remain solely responsible for materials supplied and for works carried out on his behalf by the sub contractor.
- 21.3 The contractor shall arrange for effective supervision of sub contractor's work and remain solely responsible for materials supplied and for works carried out on his behalf by the sub contractor.

22. **EXECUTION OF WORK**

All the works shall be executed in strict conformity to the provisions of the contract document and with such explanatory detailed drawings, specifications and instructions as may be approved from time to time based on detailed design and engineering carried out by contractor in line with requirements as per contract document. The contractor shall be responsible for ensuring that the work throughout are executed in the most substantial, proper and workmanlike manner with the quality of material and workmanship in strict accordance with the specifications and as per sound industrial practices and to the entire satisfaction of the RailTel.

23. Not used

24. **MAINTENANCE OF WORKS**

The contractor shall at all times during the progress and continuance of the works and also for the period of maintenance specified in the tender form and after the date of passing of the certificate of completion by the RailTel's representative or any other earlier date subsequent to the completion of the works that may be fixed by RailTel's representative be responsible for and effectively maintain and uphold in good, substantial, sound and perfect condition all and every part of the works and shall make good from time to time and at all times, as often as the RailTel's representative shall require, any damage or defect that may, during the above period, arise in or be discovered or be in any way connected with the works provided that

such damage or defect is not directly caused by errors in the contract documents, act of providence or insurrection or civil riot and the contractor shall be liable for and shall pay and make good to the RailTel or other persons legally entitled thereto whenever required by the

RailTel's representative so to do, all losses, damages, costs and expenses they or any of them may incur or be put or be liable to, by reason or inconsequence of the operations of the contractor or his failure in any respect.

For this purpose the tenderer will submit their strategy for providing maintenance support including the staff who will be available along with the set of spares for attending to various faults/problems during maintenance period.

25. CLEARANCE OF SITE

At the end of the work at each location the Contractor shall as a part of is Contractual obligation leave the area completely neat and clean.

26. PROVISIONAL ACCEPTANCE

26.1 Immediately after the completion of the work at each Block section or after completion of work in Zonal RIys/division and or sub- section to be decided by the engineer, the contractor shall certify and in writing that the installation is (i) complete (ii) ready for satisfactory commercial service and (iii) ready to be handed over.

26.2 The test or tests specified in Technical Specifications will be conducted jointly by purchaser and contractor as soon as possible after receipt of advice of completion of one section by purchaser from the contractor. The test schedule shall be finalized by mutual discussion between the contractor and RailTel. Any component, modules, sub assemblies or equipment failing during the commissioning test shall be replaced/repaired free of cost by tenderer.

26.3 Purchaser's Engineer shall issue a Provisional Acceptance Certificate for successful commissioning of a complete section covering all materials and services included in the Schedule of Requirements and the performance has been found to meet the specifications. RailTel's decision in this respect shall be final. The Provisional Acceptance Certificate shall be signed by both the parties. The period of maintenance of works shall commence from the date of issue of Provisional Acceptance Certificate of the respective section/block section and accepted by RailTel.

27. PLACING IN SERVICE & MAINTENANCE SUPERVISION

27.1 After the work has been completed & placed in service and Provisional Acceptance Certificate issued by Purchaser's Engineer, the contractor shall be responsible for proper maintenance supervision of the work for a period of twelve months from the date of issue of PAC of the each section/block section as mentioned in Clause 26.3 above.

For this purpose the tenderer shall prepare a maintenance plan and make available the services of qualified maintenance engineers stationed at the locations along with the set of spares approved by Purchaser's Engineer, to guide and only supervise the work of RailTel or Railway maintenance staff. The maintenance engineer of the contractor will visit the total installation at least once in a month. The headquarter location of their engineer where spares also will be kept on the ready shall be indicated in the maintenance plan.

27.2 During this period of maintenance supervision if any lacuna is noticed in the functioning, as a result of deficiency in the design or installation, the contractor will rectify the same free of cost. During

such rectification if any faulty equipment/modules need replacement or repair, they shall be provided by the contractor from the set of equipment or modules that the contractor should bring to the site of installation in addition to all the materials to be supplied against this contract. Use of spare modules covered under the Schedule of material of this tender shall not be permitted to be used during installation, commissioning and period of maintenance.

27.3 During the maintenance supervision period contractor should stabilize the working of the system. Purchaser has the right to extend the period of supervision of the maintenance free of cost till the system stabilizes and works satisfactorily for a reasonable period of time. If during the time any equipment etc is to be added or deficiencies are to be rectified to make the system work trouble free, the same also will have to be done by the contractor free of cost as to make good all the deficiencies.

28. FINAL ACCEPTANCE

28.1 The final acceptance of the works completed shall take effect from the date of expiry of the period of maintenance supervision as defined in Clause 27 above provided in any case that the contractor has complied fully with his obligations in respect of each item under the contract.

28.2 Notwithstanding the issue of Final Acceptance Certificate the contractor and the purchaser (subject to Sub Clause as above) shall remain liable for fulfillment of any obligation incurred under the provision of the contract prior to the issue of Final Acceptance Certificate which remains unperformed at the time such certificate is issued and for determining the nature and extent of such obligation the contract shall be deemed to remain in force between the parties hereto.

29. WARRANTY

29.1 All materials supplied/work done by the Contractor shall be guaranteed against the defects for a period as prescribed in BDS from the date of issue of Provisional Acceptance Certificate. The contractor shall provide comprehensive warranty maintenance for all the items executed by him against this tender.

29.2 During the period of warranty, the contractor shall remain responsible to arrange replacement and for setting right at his own cost any equipment installed by him which is of defective manufacture or design or becomes unworkable due to any cause whatsoever. The decision of the RailTel's representative in this regard to direct the contractor to attend to any damage or defect in work shall be final and binding on the Contractor.

29.3 During the period of warranty, the contractor shall be responsible to the extent expressed in this clause for any defects that may develop under the conditions provided for by the contract and under proper use, arising from faulty materials, design or workmanship in the plant, or from faulty execution of the plant by the contractor but not otherwise and shall remedy such defects at his own cost when called upon to do so by the Purchaser who shall state in writing in what respect the portion is faulty.

29.4 If it becomes necessary for the contractor to replace or renew any defective portions of the system under this clause the provisions of this clause shall apply to the portions of the plant to be replaced or renewed until the expiration of three months from the date of such replacement or renewal or until the end of the warranty period whichever may be later. If any defect is not remedied within reasonable time, the purchaser may proceed to do the work at contractor's risk and expense, but without prejudice to any other rights which the purchaser may have against the contractor in

respect of such defects. The tenderer has to recoup the faulty unit/equipment from the set of his own spares kept by him within a period of 24 hours. The locations where such spares are to be handed over to the Tenderer shall be indicated in the bid by the tenderer.

29.5 Deleted

29.6 Until the Final Acceptance Certificate shall have been issued, the contractor shall have the right of entry, at his own risk and expense, by himself or his duly authorized representatives, whose names shall have previously been communicated in writing to the purchaser at all reasonable working hours upon all necessary parts of the works for the purpose of inspecting the working and the records of the system and taking notes there from and, if he desires at his own risk and expense, making any tests subject to the approval of the purchaser which shall not be unreasonably withheld.

29.7 In subject of this warranty, the contractor shall make his Performance Guarantee as required under Clause 3 of Special Conditions of Contract, valid to cover the period of warranty as per Clause 29.4

29.8 Tenderer shall quote the repair charges as percentage of the costs of each module/ card/assembly/ subassembly, which will remain valid for 2 years after the free warranty maintenance. RailTel may exercise the options of getting the defective modules/ cards repaired from the contractor for 2 years after the free warranty maintenance period is over, at the costs quoted by the tenderer.

30. **TRAINING (NOT APPLICABLE FOR THIS TENDER)**

30.1 The tenderer shall undertake to train RailTel engineers and other Railway staff nominated by the RailTel in different aspects of equipment designs, functioning, field installation, testing, commissioning, operation, maintenance and repair, covering both hardware and software. The training should be comprehensive for transfer of complete know-how so as to impart full knowledge and competence to independently and successfully execute the installation, operation, user related software changes, maintenance and repair of all equipment. The training courses should, apart from formal class room training, include hands on practical experience at the manufacturer's premises or other locations and visits to working installation.

30.2 In the event of any equipment/sub-system being manufactured in India in technical collaboration with foreign firm by the tenderer or any of its sub-contractor, the training as per schedule shall be provided at the collaborator's premises/training centre in India at the Purchaser's discretion. Tenderer may quote separately against this schedule for the two options separately if required.

30.3 The contractor shall at every stage of installation; testing and commissioning provide all facilities for adequate training of RailTel personnel who may be deputed to work on the project.

30.4 The requirement of training in man-weeks has been indicated in the schedule of requirements. The tenderer shall quote for the man week rates duly taking in to account Para 30.2 above. Details of training proposal shall be submitted by the tenderer.

30.5 Set of Documents related to training to each of the trainees shall be provided.

30.6 All expenses for travel to and from the place of training, boarding and lodging of the trainees shall be borne by the RailTel.

31. **INFRINGEMENT OF PATENTS:**

- (a) The Contractor is forbidden to use any patents or registered drawings, processes or patterns in fulfilling his contract without prior consent in writing of the owner of such patents, drawings, patterns or trade marks except where these are specified by the Purchaser himself. Royalties where payable for the use of such patented processes, registered drawings or patterns shall be borne exclusively by the Contractor. The Contractor shall advise the Purchaser of any proprietary rights that may exist on such processes, drawings or patterns which he may use of his own accord.
- (b) In the case of patents taken out by the Contractor of the drawings or patterns registered by him or of those patents, drawings or patterns for which he holds a license, the signing of the contract automatically gives the Purchaser the right to repair by himself the purchased articles covered by the patent or by any person or body chosen by him and to obtain from any sources he desires the component parts required by him for carrying out the repair work. In the event of infringement of any patent rights due to above action of the Purchaser he shall be entitled to claim damages from the Contractor on the grounds of any loss of any nature which he may suffer e.g. in the case of attachment because of counterfeiting.

32. LICENSE AS PER GOVT. OF INDIA CONTRACT LABOUR ACT

The Contractors are required to produce license as enjoined in the Government of India Contract Labour (Regulation and Abolition) Act (1978) with latest amendments, if any. They shall not be allowed to undertake or execute any work through contract Labour except under and in accordance with a license issued under the said Act in that behalf by the authorized licensing Officer.

33. DEFAULTS AND DELAYS

The Contractor shall execute the work with due diligence and expedition, keeping to the approved time schedule. Should he refuse or neglect to comply with any reasonable orders given to him in writing by the Purchaser's Engineers in connection with the work or contravene the provision of the Contract or the progress of work lags persistently behind the time schedule due to his neglect, the Purchaser shall be at liberty to give seven days notice in writing to the Contractor requiring him to make good the neglect or contravention complained of and should the Contractor fail to comply with the requisitions made in the notice within seven days from the receipt thereof, it shall be lawful for the purchaser to take the work wholly or in part out of the Contractor's hands without any further reference and get the work or any part thereof, as the case may be, completed by other agencies at the expense of the Contractor without prejudice to any other right or remedy of the Purchaser. The contract shall be treated as terminated on the date a notice is issued by the purchaser to take the work wholly or in part out of the Contractor's hands. The purchaser shall be at liberty to encash the performance guarantee and forfeit the security deposit after the contract is terminated to reimburse the loss to purchaser.

34. LOSS SUSTAINED DUE TO DEFAULTS AND DELAYS

In the event of any loss to the purchaser on account of execution and/or completion of the work or any part thereof by agencies other than the contractor, in terms of clause 33 the contractor shall be liable to reimburse the loss to purchaser without prejudice to the other rights and remedies of the purchaser and the reimbursement in full or in part, as the case may be, shall be met at the option of the purchaser from out of all or any of the following sources viz :

- (a) i) Any amount due and payable to the contractor by the purchaser on any account whatsoever;

- ii) The Contractor's security deposit in the hands of the purchaser as far as available, and;
 - iii) Any other assets whatsoever of the contractor;
- (b) In the event of re-imburement from out of sources (i) and/or (ii) above mentioned, the purchaser shall have the right of appropriation suo moto.

35. PENALTY FOR DELAY IN COMPLETION

- 35.1 If the contractor fails to execute and complete the work within the time specified in the Agreement or within the period of extension granted under clause 36, for any reason whatsoever other than the non availability of the terminated OFC, 220V power supply and the Equipment Room, the contractor shall accept reduction in the total amount payable to him by the purchaser at the rate of 0.5% per week or part thereof (rounded off to the nearest whole number) of the total value of the contract for the delay occasioned beyond the appointed time by which the work should have been completed under the contract.
- 35.2 The total value of penalty on account of above shall be limited to maximum of 10% (Ten percent) of the total contract value.
- 35.3 Such reduction shall be accepted by the purchaser in full satisfaction of the contractor's liability arising from delay only. This penalty for delay in completion will be applicable separately for each stage of completion of work when two or more stage of completion are specified in the contract. The purchaser's engineer shall at his sole discretion specify a time limit within which the unfinished portion of the work shall be completed after serving on the contractor a notice of Purchaser's intention to recover the said penalty in Form 11. In the event of failure of the contractor, the purchaser shall be at liberty to take action in accordance with provisions in Clause 33 and 34.

NOTE: For purpose of this clause the value of work shall be calculated on the basis of unit prices included in schedule of requirements.

36. ADHERENCE OF TIME SCHEDULE

- 36.1 Timely completion of the work is the essence of the contract. Delay in execution will attract penalty.
- 36.2 If any delay as aforesaid in clause 35 shall have arisen from any cause which the Purchaser may agree as being a reasonable ground for extension of time the purchaser's engineer or his representative may allow such additional time as he may in his absolute discretion consider to be reasonably justified by the circumstances of the case. Such extensions shall be granted , on request from contractor, with or without liquidated damages in the Form No.11 (Section-I, Chapter-6).

37. CONTRACTOR'S LIABILITIES FOR COSTS AND DAMAGES

Please refer clause 52 of General Condition of Contract (Part II of Chapter 3, Section I).

38. UNIT PRICES

- 38.1 The prices quoted by the Tenderer shall include the prices of materials including all incidental charges for transport, loading/ unloading and handling of materials, commission for arranging

dispatch by rail direct from manufacturer's factory and completing all necessary formalities in this respect, such as submission of forwarding notes, arranging placement of Wagon, collection of banker's charges for Bank guarantee, Indemnity Bonds inclusive of cost of Stamp etc. as also siding or shunting charges, if any, levied by the Railway.

- 38.2 The prices shall include all taxes, duties, Royalty, entry tax and levies (including Octroi etc.) applicable on this Works Contract. Therefore, they should quote their prices taking into account all types of taxes including sales tax on works contract as leviable. Ambiguous charges without firm and specific figures quoted as "extra" will make the bid liable to be summarily rejected. Form 'C' if required by contractor shall be supplied by Regional General Manager Northern Region, Delhi.
- 38.3 The prices quoted by the tenderer shall include cost of commissioning and testing and all costs of Administration of Contract, Insurance Premium, Banker's charges for guarantees, cost of storage, loading-unloading and handling of materials and for any road transport which the contractor may use for carriage of materials to his depot and the site of work. The prices shall include the cost of works and adjustments necessary to be done by the contractor during or after tests carried out by the purchaser.
- 38.4 The price to be quoted by the tenderers should take into account the credit availed on inputs under the MODVAT scheme introduced w.e.f. 1st March 1986. The tenderers should give a declaration that any set off in respect of duties on inputs as admissible under law is being totally and unconditionally passed on to the purchaser in the price quoted by him (see clause 43).
- 38.5 While the price quoted in the contract are inclusive of all taxes i.e. excise duty, octroi, local levies, sales tax levied by any statutory authority, the purchaser shall make any deduction toward sales tax on works contract if statutorily required to do so. The deducted sales tax on works contract shall be remitted to the concerned sales tax authority and the purchaser shall in no way be responsible for any disputes between the sales tax authorities and the contractor in this regard.
- 38.6 All taxes, duties and levies (Including octroi etc.) arising out of the transaction between the contractor and his sub contractor/supplier for this work will be included in the rates quoted by the contractor in the relevant Schedule.
- 38.7 No import license shall be arranged by the RailTel for this work.

39. MEASUREMENT OF WORKS

- 39.1 Payments for the works shall be made in accordance with approved designs & drawings and measured in relevant units except where provided or otherwise. The measurements will be made generally in accordance with standard engineering practices.
- 39.2 All measurement, method of measurement, meaning intent of specifications and interpretation of Special Conditions of Contract, given and made by the Purchaser or by the Purchaser's Engineer shall be final and binding.
- 39.3 All payments due to the Contractor shall be made by RTGS/NEFT only.
- 39.4 Payments for the works shall be made in accordance with approved design & drawings and measured in relevant units except where provided or otherwise. The measurements will be made generally in accordance with standard engineering practices. The abstract of quantities arrived shall be entered in the measurement book and signed by the contractor and the authorised representative of RAILTEL.

40. **TERMS OF PAYMENT**

40.1 All bills shall be submitted to the Territory Manager, Northern Region under whose jurisdiction the work has been executed. While submitting the bills, the break-up of taxes may be furnished so that any CENVAT/INPUT credit may be availed by RailTel.

40.2 **DELETED**

40.3 Subject to any deductions or recovery which the RailTel may be entitled to make under contract, the Contractor will be entitled to be paid from time to time by way of 'on account payment' for supply of goods and 'progress payment' for works as in the opinion of the Engineer he has executed in terms of Contract.

40.4 **ON ACCOUNT PAYMENT FOR SUPPLY OF EQUIPMENT & MATERIAL**

“On account payment” for supply of equipments, materials indicated in the Schedule of Requirements subject to recoveries of liquidated damages, if any, shall be made as given below:

75% (Seventy five percent) of the value of equipments/ material supplied of each consignment shall be paid on production of the following documents :

- (a) On receipt of materials at site as certified by the purchaser’s representative.
- (b) Original Inspection certificate issued by Inspecting Officer.
- (c) Challan / Invoice in duplicate.
- (d) A certificate that the materials supplied are as per the contract and the amount claimed in the invoice is correct as per terms of the contract.

40.4.1 The on account payments made will subsequently be adjusted against payments due on Provisional Acceptance or Final Acceptance.

40.4.2 15% (Fifteen percent) value of goods supplied shall be paid after the successful completion of installation & commissioning of these equipments at various locations and commissioning of the hops/block section concerned and completion of all measurements and testing to the satisfaction of Engineer.

40.4.3 5% (Five percent) value of the goods supplied shall be paid after the successful completion of installation & commissioning of whole system as and issue of “Provisional Acceptance Certificate by Purchaser's Engineer .

40.4.4 20% payment against the items supplied under the Schedule of supply but not installed/not required to be installed shall be paid after the successful completion of installation & commissioning of whole system and issue of "Provisional Acceptance Certificate for the last section by Purchaser's Engineer. The bank guarantee for on account payment (40.2) above shall be released.

40.5 **PROGRESS PAYMENT FOR EXECUTION OF WORKS:**

'Progress payment' shall be made separately for each item/sub-item of work given in the Schedule of Requirements (SORs).

- 40.5.1 **90%** (Ninety percent) of the progress payment for each item of Schedule of Requirements shall be paid **for the quantities completed** at various locations after joint measurement and testing to the satisfaction of Engineer / supervisor in-charge of the work and proper entry in the Measurement book jointly by contractor and Engineer/supervisor in-charge of RailTel.
- 40.5.2 **5%** (Five percent) value of the works/services completed shall be made on issue of Provisional Acceptance Certificate by RailTel as per clause 12 above.

41. FINAL PAYMENT

Final payment of **5%** (Five percent) of the contract value shall be made after satisfactory operation & maintenance of the work under the supervision of the contractor for a period of one year after commissioning and issue of Final Acceptance Certificate.

- 41.1 On the basis of Final Acceptance Certificate from the Purchaser's Engineer for all the works at all the locations covered in this contract and reconciliation of materials issued, the final bill for the balance payment for each item of work shall be submitted by the Contractor along with a clear 'No Claim Certificate'. The Final Acceptance Certificate shall be issued by the Purchaser's Engineer only when he has accepted the work wholly after conducting the acceptance tests as per the details given in the technical specification and supplement.

42. FINAL SETTLEMENT

On expiry of the warranty period and issue of the certificate of final acceptance of the entire installations, the security deposit (Clause 3) will be refunded or Bank Guarantee released to the Contractor after adjustment of any dues payable by the contractor.

43. CERTIFICATES FOR MODVAT BENEFITS ON BILLS

- a) The Contractor should submit the following certificate along with the bills:-
(see clause 38.4) "We certify that no additional duty set offs on the Goods supplied by us have accrued under the MODVAT Scheme in force on the date of supply after we submitted our quotations and submitted the present bill".
- b) In the event of MODVAT credit being extended by the Government of India to more items that already covered, the firm should advise the purchaser about the additional benefits accrued through a letter containing the following certificate, or any variation thereof, as may be considered necessary by RailTel administration:- "We hereby declare that we can avail additional duty set offs as per latest MODVAT scheme in force now and we hereby give a reduction of (-----) per unit and agree to revise the prices indicated in the order. The current E.D. of (-----) is payable on this reduced price. Therefore, we request you to amend the order accordingly."

44. DEDUCTION FROM ON ACCOUNT PAYMENT BILLS

- (i) All costs, damages or expenses, which RailTel may have been paid or incurred which under the provisions of contract are Contractor's obligations will be deducted by RailTel from progress payment Bills/Invoice of Contractor, as and when it is understood that such an expense has been incurred or paid for.

- (ii) All such claims of RailTel shall, however, be duly supported by appropriate and certified vouchers, receipts or explanations as are available to enable the Contractor to identify such claims.

45 TAXES

45.1 The Contractor and all personnel employed by him shall pay such taxes like Income Tax as are payable under statutory laws of India and the Purchaser WILL NOT ACCEPT any liability for the same.

45.2 Deduction of Income Tax at source as per provisions of Finance Act and Income Tax in force shall be made from the Contractor/Sub-Contractor and the amount so deducted may be credited to the Central Government.

45.3 Wherever the law makes it statutory for the Purchaser to deduct any amount towards Sales Tax on Works Contract, the same will be deducted and remitted to the concerned authority.

46. **MOBILISATION ADVANCE:** Deleted.

47. INSURANCE

47.1 The Contractor shall take out and keep in force a policy or policies of insurance from the date, the delivery of material start against all liabilities of the Contractor or the Purchaser at common law or under any statute in respect of accidents to persons who shall be employed by the contractor in or about the site for the purpose of carrying out the works on the site. The Contractor shall also take out and keep in force a policy or policies of Insurance against all recognized risks to their offices and depots. Such insurance shall in all respects be to the approval of the Purchaser and if he so requires in RailTel's name.

47.2 INSURANCE OF MATERIALS & INSTALLATIONS

The Contractor shall take out and keep in force a Policy or policies of Insurance for all materials including RailTel supply materials/ equipments irrespective of whether used up in the portion of work already done or kept for the use in the balance portion of the work until such works are provisionally handed over to the RailTel. For this purpose, the works are deemed to have been provisionally handed over when provisional acceptance certificate is issued for the locations as per clause 26.

47.3 The Contractor shall not be liable for losses/damages to the materials either used up in the portion of work done or his material kept for use at site, in consequence of Mutiny, or other similar causes over which the Contractor has no control and which cannot be insured. Such losses or damages shall be the liability of the Purchaser and if required by the Purchaser, be made good by the contractor at the cost of the Purchaser.

47.4 The Contractor should, however, insure the stores brought to site, against risks in consequence of war and invasion, as required under the Emergency Risk (Goods) Insurance Act in force from time to time.

47.5 It may be noted that the beneficiary of the insurance policy should be RailTel or the policies should be pledged in favour of RailTel. The contractor shall keep the policy/policies current till the installations are provisionally handed over to the purchaser. It may also be

noted that in the event of contractor's failure to keep the policy current and alive, renewal of policy will be done by purchaser for which the cost of the premium plus 20% of premium shall be recovered from the contractor.

47.6 For the purpose of enabling the contractor to take the insurance cover in connection with this contract, the purchaser's Engineer will advise the approximate price of all the RailTel supply materials to the Contractor.

48. Rights of RailTel:

RAILTEL reserves to itself the following rights in respect of this contract without entitling the Contractor to any compensation.

48.1 To get the work done through another agency at the risk and cost of the Contractor, in the event of poor progress or the Contractor's inability to progress the work for Completion as stipulated in the contract, poor quality of work, persistent disregard of instructions of Architect / **RAILTEL**, assignment, transfer, subletting of the contracted work without written permission of **RAILTEL**, non-fulfillment of any contractual obligations etc. and to claim / recover compensation for such losses from the Contractor including **RAILTEL**'s supervision charges and overheads from Security Deposit / other dues.

48.2 To withdraw any portion of work and / or to restrict / alter quantum of work as indicated in the contract during the progress of work and get it done through the contractor of the adjacent section and / or by the departmental labour to suit **RAILTEL**'s requirements or in case **RAILTEL** decides to advance the compensation due to other emergent reasons.

48.3 To terminate the contract after due notice and forfeit the Security Deposit and recover the loss sustained in getting the balance work done through other agencies in addition to liquidated damages in the event of:

- Contractor's continued poor progress.
- Withdrawal from or abandonment of the work before completion of the work.
- Corrupt act of the Contractor.
- Insolvency of the Contractor.
- Persistent disregard of the instructions of **RAILTEL**.
- Assignment, transfer, subletting of the contract work without written permission.
- Non-fulfillment of any contractual obligations.

48.4 To recover any moneys due from the Contractor from out of any moneys due to the Contractor under this or any other Contract or from the Security Deposit.

48.5 To determine the Contract or to restrict the quantum of work and pay for the portion of work done as per the satisfaction of **RAILTEL**.

48.6 To effect recoveries from any amounts due to the Contractor under this or any other contract or in any other form the moneys which **RAILTEL** is forced to pay to anybody due to Contractor's failure to fulfill any of his obligations.

48.7 To restrict or increase the quantity and nature of work to suit site requirements, since the tender specifications are based on preliminary documents and quantities furnished therein are indicative and approximate and the rates quoted shall not be subject to revision in any manner whatsoever.

48.8 To deploy **RAILTEL's** or adjacent-section-contractor's skilled and semiskilled workmen in case of emergency / poor progress / deficiency in skill on the part of the employees of the Contractor and to recover the expenditure on account of the same from the moneys due to the Contractor.

48.9 While every endeavour will be made by **RAILTEL** to this end, **RAILTEL** cannot guarantee uninterrupted work due to conditions beyond its control. The Contractor will not be entitled to any compensation / extra payment on this account.

In the event of any dispute of technical nature, the decision of RAILTEL shall be final and binding to the Contractor.

49. Responsibilities of Contractor in respect of local taxing rules, local laws, employment for workers etc.:

The following are the responsibilities of the Contractor in respect of observance of local laws, employment of personnel, payment of taxes etc.

49.1 The tenderer must be registered in relevant states for the payment of Works Contract Tax OR tenderer must register for the same and produce the same along with the bills for payment.

49.2 As far as possible, unskilled workers shall be engaged from the local areas in which the work is being executed.

49.3 The Contractor at all times during the continuance of this contract, shall in all his dealings with the local labour for the time being employed on or in connection with the work, has due regard to all local festivals, religious and other customs.

49.4 The Contractor shall comply with all State and Central Laws, Statutory Rules, Regulations etc., such as The Payment of Wages Act, The Minimum Wages Act, The Workmen's Compensation Act, The Employer's Liability Act, The Industrial Disputes Act, The Employee's Provident Fund Act, Employee's State Insurance Scheme, The Contract Labour (Regulations and Abolitions Act, 1970) and other Acts, Rules and Regulations for labour as may be enacted by the Government during the tenure of the Contract and having force or jurisdiction at site. The Contractor shall give to the local Governing Body, Police and other concerned authorities all such notice as may be required under law.

49.5 The Contractor will obtain independent licence under the Contract Labour (Regulations and Abolition Act, 1970) from the concerned authorities based on the certificate (Form -V) issued by the principal employer / customer, if such license is required under the law.

49.6 The Contractor shall pay all taxes, fees, licence charges, deposits, duties, tolls, royalty, commissions or other charges which may be leviable on account of any of his operations connected with this contract. In case, RAILTEL is forced to make any such payment, RAILTEL shall recover the same from the Contractor either from moneys due to him or otherwise as deemed fit.

49.7 The Contractor shall be responsible for the provision of health and sanitary arrangements more particularly described in the Contract Labour (Regulations and Abolition Act, 1970) and safety precautions as may be required for safe and satisfactory execution of the contract.

49.8 The Contractor shall be responsible for proper accommodation including adequate medical facilities for the personnel employed by him.

- 49.9 The Contractor shall be responsible for the proper behaviour and observance of all regulations by the staff employed by him.
- 49.10 The Contractor shall ensure that no damage is caused to any person / property of other parties working at site. If any such damage is caused, it shall be the responsibility of the Contractor to make good the losses and compensate them.
- 49.11 All the properties/equipment/components of **RAILTEL** loaned with or without deposit, to the Contractor shall remain the properties of **RAILTEL**. The Contractor shall use such properties for the purpose of execution of this contract. All such properties/ equipment / component shall be taken to be in good condition unless notified to the contrary by the Contractor within 48 hours. The Contractor shall return them in good condition as and when required by **RAILTEL**. In case of non-return, loss, damage, repairs etc., the cost thereof, as may be fixed by the Engineer, will be recovered from the Contractor.
- 49.12 It shall not be obligatory on the part of **RAILTEL** to supply any tools and tackles or materials other than those specifically agreed to be given by **RAILTEL**.
- 49.13 The Contractor shall fully indemnify and keep indemnified **RAILTEL** against all claims of whatever nature arising during the course of execution of this contract.
- 49.14 In case the Contractor is required to undertake any work outside the scope of this contract, the amount payable shall be as may be mutually agreed upon.
- 49.15 Any delay in completion of works or non-achievement of periodical targets, due to reasons attributable to the Contractor, will have to be compensated by the Contractor either by increased manpower and resources or by working extra hours or more than one shift at no extra cost to **RAILTEL**.
- 49.16 The Contractor will be directly responsible for payment of wages to his workmen. A pay-roll sheet giving details of all payments made to the workmen duly signed by the Contractor's representative should be furnished to **RAILTEL**, if called for.
- 49.17 In case of any class of work for which there is no specification laid down in the contract, such work shall be carried out in accordance with the instructions and requirements of the Engineer.
- 49.18 No levy, payment or charges made or imposed shall be impeached by reason of any clerical error or by reason of any mistake in the amount levied, demanded or charged.
- 49.19 No idle labour charges will be admissible in the event of any stoppage of work resulting in the Contractor's workmen being rendered idle due to any reason at any time.
- 49.20 The Contractor shall take all reasonable care to protect the materials and the work till such time it has been taken over by **RAILTEL**.
- 49.21 Contractor shall not stop work or abandon the site for whatsoever reason or dispute, excepting for force majeure conditions. All problems / disputes shall be separately discussed and settled without effecting the progress of work. Stoppage or abandonment of work other than under force majeure conditions shall be treated as breach of work of contract and dealt with accordingly.

- 49.22 The Contractor shall keep the area of work clean and shall remove the debris etc. outside of RailTel's premises, while executing day-to-day work. Upon completion of work, the Contractor shall remove from the vicinity of work, all scrap, packing materials, rubbish, unused and other materials and deposit them in places specified by the Engineer. The Contractor will also demolish all the hutments, sheds, offices, etc., constructed and used by him and shall clean the debris. In the event of his failure to do so, the same will be arranged to be done by the **RAILTEL** and the expenses recovered from the Contractor.
- 49.23 The Contractor shall execute the work in the most substantial and workmen like manner in the stipulated time. Accuracy of work and timely execution shall be the essence of this contract. The Contractor shall be responsible to ensure that the quality, assembly and workmanship conform to the dimensions and clearance given in the drawings and/or as per the instructions of the Engineer.
- 49.24 The Contractor shall furnish fortnightly labour deployment report indicating the classification and number of workmen engaged, date wise and category wise. Besides, the Contractor shall also furnish progress reports on work at regular intervals as required by the Engineer.
- 50. Responsibility of contractor in respect of safety of men, equipment, material and environment:**
All safety rules and codes applied by **RAILTEL** at site shall be observed by the Contractor and his workmen without exception. The Contractor shall be responsible for the safety of the equipment / material and work to be performed by him.
- 50.1 Contractor shall also take such additional precautions as may be indicated from time to time by the Engineer, with a view to prevent pilferage, accidents, fire hazards etc. Suitable number of Clerical Staff, watch and ward, Storekeepers to take care of equipment, material, construction tools and tackles shall be posted at site by the Contractor till the completion of work under this contract. The Contractor shall arrange for such safety devices as are necessary for this type of work and carry out the requisite site tests of handling equipment, lifting tools, tackles etc. as per usual standards and practices.
- 50.2 The Contractor shall provide to its work force and ensure the use of the following personal protective equipment as found necessary and as directed by the authorized **RAILTEL** officials:
- Safety Helmets conforming to IS - 2925.
 - Safety Belts conforming to IS - 3521.
 - Safety Shoes conforming to IS - 1989.
 - Eye & Face Protection devices conforming to IS-8520 & IS-8940.
 - Hand & Body Protection devices conforming to IS-2573, IS-6994, IS-8807 & IS-8519.
- 50.3 All tools, tackles, lifting appliances, material handling equipment, scaffolds, cradles, safety nets, ladders, equipment etc. used by the Contractor shall be of safe design and construction. These shall be tested and certificate of fitness obtained before putting them to use and from time to time as instructed by authorized **RAILTEL** official who shall have the right to ban the use of any item.
- 50.4 All electrical equipment, connections and wiring for construction power, its distribution and use shall conform to the requirements of Indian Electricity Act and Rules. Only electricians licensed by the appropriate statutory authority shall be employed by the Contractor to carry out all types of electrical works. All electrical appliances including portable electric tools used by Contractor shall have safe plugging system to source of Power and be appropriately earthed.
Where it becomes necessary to provide and / or store petroleum products, explosives, chemicals and liquid or gaseous fuel or any other substance that may cause fire or explosion, the Contractor shall be responsible for carrying out such provision and / or storage in accordance with the rules

and regulations laid down in the relevant Government Acts, such as Petroleum Act, Explosive Act, Petroleum and Carbide of Calcium Manual of the Chief Controller of Explosives, Government of India etc. Prior approval of the authorized **RAILTEL** official at the site shall also be taken by the Contractor in all such matters.

- 50.5 The Contractor shall arrange at his cost (wherever not specified) appropriate illumination at all work spots for safe working, when natural daylight may not be adequate for clear visibility.
- 50.6 In case of a fatal or disabling injury/accident to any person at construction sites due to lapses by the Contractor, the victim and/or his/her dependants shall be compensated by the Contractor as per statutory requirements. However, if considered necessary, **RAILTEL** shall have the right to impose appropriate financial penalty on the Contractor and recover the same from payments due to the Contractor for suitably compensating the victim and/or his/her dependents. Before imposing any such penalty, appropriate enquiry shall be held by **RAILTEL** giving opportunity to the Contractor to present his case.
- 50.7 In case of any damage to property due to lapses by the Contractor, **RAILTEL** shall have the right to recover the cost of such damages from the payments due to the Contractor after holding an appropriate enquiry.
- 50.8 In case of any delay in the completion of jobs due to mishaps attributable to lapses by the Contractor, **RAILTEL** shall have the right to recover cost of such delay from the payments due to the Contractor, after notifying the Contractor suitably and giving him opportunity to present his case.
- 50.9 If the Contractor fails to improve the standards of safety in its operation to the satisfaction of **RAILTEL**, after being given reasonable opportunity to do so and / or if the Contractor fails to take appropriate safety precautions or to provide necessary safety devices and equipment or to carry out instructions regarding safety issued by the authorised **RAILTEL** official, **RAILTEL** shall have the right to take the corrective steps after giving a notice of not less than seven days indicating the steps that would be taken by **RAILTEL**.
- 50.10 The Contractor shall submit report of all accidents, fires, Property damage and dangerous occurrences to the authorised **RAILTEL** official immediately after such occurrence, but in any case not later than 12 hours of the occurrence. Such reports shall be furnished in the manner prescribed by **RAILTEL**. In addition, periodic reports on safety shall also be submitted by Contractor to the authorised **RAILTEL** official from time to time as prescribed.
- 50.11 During the course of construction, alteration or repair scrap lumbars with protruding nails, sharp edges etc., and all other debris including combustible scrap shall be kept cleared from working areas, passage ways and stair in and around site.
Cylinders shall be moved by tilting and rolling them on their bottom edges. They shall not be intentionally dropped, struck or permitted to strike each other violently. When cylinders are transported by powered vehicles, they shall be secured in a vertical position.
- 50.12 All the Contractor's supervisory personnel and sufficient number of workers shall be trained for fire fighting and shall be assigned specific fire protection duties. Enough number of such trained personnel must be available during the tenure of the contract.
- 50.13 Contractor shall provide enough fire protecting equipment of the types and numbers at his office, stores, erection site, other temporary structures, labour colony area etc. Access to such fire protection equipment shall be easy and kept open at all times. Compliance of the above requirement

under fire protection shall in no way relieve the Contractor of any of his responsibility and liabilities to fire accident occurring. In the event fire safety measures are not to **RAILTEL's** satisfaction, **RAILTEL** shall have option to provide the same and recover the cost plus incidentals from Contractor's bills and / or impose penalty as deemed fit by the authorised representative of **RAILTEL**.

51. Deleted.

52. Strikes and Lockouts:

The Contractor will be solely responsible for all disputes and other issues connected with his workmen. In the event of Contractor's workmen resorting to strike or the Contractor resorting to lockout and if the strike or lockout so declared is not settled within a period of one month, **RAILTEL** shall have the right to get the work executed by employing its own men or through other agencies or both. The cost incurred by **RAILTEL** in this regard shall be recovered from the Contractor.

For any purpose whatsoever, the employees of the Contractor shall not be deemed to be in the employment of **RAILTEL**.

53. Guarantee:

Even though the work will be carried out under the supervision of the authorized representative of **RAILTEL**, the Contractor will be responsible for the quality of the workmanship and shall guarantee the work done for a period of **one year from the date of completion of work** as certified by the authorized representative of **RAILTEL** and shall rectify free of cost to **RAILTEL** all defects arising out of faulty erection during the guarantee period starting from the date of completion of rectification. In the event of the Contractor failing to repair the defective works within the time specified by the authorized representative of **RAILTEL**, **RAILTEL** may proceed to undertake the repairs of such defective works at the Contractor's risk and cost, without prejudice to any other rights and recover the same from out of any moneys payable to the Contractor or by other legal means.

53.1 The Tenderers has to enter in the register all the material / tools and plants brought to the site for working in the premises available with the Security Staff / Site Incharge / Site Register.

53.2 The Tenderers should get all the materials inspected and approved from the authorized representative of **RAILTEL** before use. In case of non-approval, if authorized representative of **RAILTEL** wish to check the material, cost of breakages and re-doing the same Work will be the sole responsibility of the Contractor own.

53.3 The rates should be quoted in the same units as mentioned in the tender schedule. The Bill of Quantities enclosed are very indicative and can vary as per the Site conditions, requirements of **RAILTEL** or Design of authorized representative of **RAILTEL** and the rates quoted shall not be subject to revision.

53.4 The rates quoted in the tender shall include all charges of material, labour, lifts, scaffoldings, any tools & plants, freight, labour conditions, fluctuations in the rates, Sales tax, excise duty, shift working, Octroi & other taxes and shall be firm for the duration of the contract and any extended period of the contract. No escalation in the rates shall be allowed under any circumstances even in case of extension of time period.

53.5 The successful Tenderer is bound to carry out all the items of work necessary for the completion of the job even though the same may not have been included in the schedule of quantities. Rates for such items shall be settled in consultation with authorized representative of **RAILTEL**.

The successful Tenderer will have to make samples (proto-type) of all the furniture items for the final approval of authorized representative of RAILTEL before taking up the entire execution of the work. In case of any modifications / additions, the same shall be incorporated in the entire furniture items without any additional financial implications.

Water and Electricity shall be provided free of cost at one point on each floor, further extensions if required shall be borne / arrange by the Tenderer on its own.

54. Rates of extra items/quantity:

The rates of the extra items will be derived from the tender wherever possible.

- 54.1 In case the rates do not exist in the tender, the rate will be derived as per the market rates. The Tenderer shall submit analysis of rates as per Annexure, with assumption of any one item.
- 54.2 If the quantity of any item under execution is varying up to $\pm 25\%$ of the total quantity (as per the Schedule of Requirement), the contractor shall have to execute the same item at **similar rates** as applicable in the contract agreement.
- 54.3 RailTel reserves the rights to vary the quantity by 25% above or below the BOQ without assigning any reason to the contractor.
- 54.4 All the work executed should be got approved by the authorized representative of RAILTEL and in case of any bad workmanship pointed out shall be either rectified or be taken away from the site if it is not rectifiable and shall be replaced without any extra cost by the Tenderer.
- 54.5 The Tenderer should indicate the breakup of the items of %age of the unit cost for material, wastage, labour, taxes, profits & overheads, etc. separately. This %age shall be the basis for evaluation of the rates of the extra items.
Measurements of the items shall be as per the IS1200 / CPWD manual / BOQ units.
- 54.6 All Government taxes, levies etc. like Works Contract – Sales Tax, TDS shall be deducted from all the running bills of the Contractors.
- 54.7 All the works executed or under execution finished or semi-finished including all materials lying at site shall become the property of RAILTEL immediately on receipt of bills of the Contractors for the same.
- 54.8 The procurement of Cement, Steel, as required for completion of work shall be the responsibility of the Contractor.
- 54.9 All Fittings / Fixtures, Materials shall conform to the relevant ISI specifications and Shall be approved by the authorised representative of RAILTEL



SECTION-I

CHAPTER - 5

BID DATA SHEET (BDS)

SECTION-I

CHAPTER-5

BID DATA SHEET (BDS)

The section consists of provisions that are specific to various clauses of Preamble, Instruction to Tenderers and conditions of tendering (ITT), General Condition of Contract (GCC) and Special Condition of Contract (SCC) of Section-I of the tender document.



BID DATA SHEET (BDS)

Reference Clause	Description
Name of the Work: (Preamble Clause 1)	Supply & Laying of OFC, HDPE Duct, Power Cable, etc. for providing WiFi Services at 10 Nos. Railway Stations of Chandigarh Territory of Northern Region.
List of Section/s where work for RailTel is to be done: (Preamble Clause 2.4)	Ambala Cantt, Amritasr, Bareilly, Chandigarh, Haridwar, Jalandhar City, Jammu Tawi, Ludhiana, Moradabad & Dehradun Railway Station
Pre bid Conference: (Preamble Clause 3)	NIL Venue: Date: Time:
Last Date, Time and Venue of Submission of Tender: (Preamble Clause 6)	Venue: RailTel Corporation of India Ltd, Northern Region Office, 6th floor, Block-III, Delhi IT Park Shastri Park, Delhi-110 053 Date: 11.05.2016 Time: 15:00 hours
Date, Time and Venue of Opening of Tenders: (Preamble Clause 7)	Venue: Same as above Date: 11.05.2016 Time: 15:30 hours
Completion Period of Work: (Preamble Clause 8)	180 days from the date of issue of Letter of Acceptance (LOA).
Authority and Address: (Preamble Clause 9)	Regional General Manager, Northern Region, RailTel Corporation of India Ltd, 6th floor, Block-III, Delhi IT Park Shastri Park, Delhi-110 053

Earnest Money: (Preamble Clause 10)	Rs. 1,90,000/- (Rupees One Lac Ninety Thousand only).
Form of Earnest Money: (ITT Clause 7.4)	Pay Orders / Demand Drafts shall be drawn in favour of RailTel Corporation of India Limited, payable at Delhi having validity covering 90 days beyond the validity of offer.
Work to be done by RailTel (if any): (Preamble Clause 15)	NIL
Materials to be supplied by RailTel (if any): (Preamble Clause 16)	1. HDPE Duct (33/40 mm dia) with accessories. The materials shall be supplied from the store of Site Engineer. No extra transportation cost shall be paid by RailTel to contractor.
Unit Prices: (ITT Clause 12)	The unit rate and the prices shall be quoted by the bidder entirely in Indian Rupees (INR) only. Quoting in Foreign currency is not applicable to the present tender even for the imported items/ components of the Schedule of Requirements.
Validity of offer: (ITT Clause 13)	90 days (Ninety days) from the date of opening of tender
Minimum Qualifying Criteria: (ITT Clause 19.1.4(i))	I. Technical: The tenderer shall necessarily satisfy the <u>eligibility conditions</u> as listed below:- 1.1 The tenderer should have completed in the last three financial year (i. e. current year and three previous financial years) at least one similar single work for a minimum value of 35% of the advertised tender value of the work. 1.2 Similar nature of work physically completed within the qualifying period, i.e. the last 3 financial year and current financial year (even though the work might have commenced before the qualifying period) shall only be considered in evaluating the eligibility criteria. 1.3 The total value of similar nature of work completed during the qualifying period and not the payments received within qualifying period alone, shall be considered.
Annual Turnover: [ITT Clause 19.1.4 (ii)]	II. Financial: The total contact amount received by the tenderer during the last three years should be a minimum of 150% of the advertised tender value of the work. (Last audit report from registered Chartered Accountant to be enclosed).

<p>Meaning of similar Works: (ITT Clause 20)</p>	<p>Works similar to the scope of work as contained in this tender shall mean</p> <p>i) OFC works including Trenching, Laying, Jointing, Splicing, Testing and Commissioning of Optical Fibre Cables/ Telecom Cable works.</p> <p style="text-align: center;">(OR)</p> <p>ii) Installation & Commissioning of public Wi-Fi networks in Railway Stations / Metro Railway Stations/ Airports / Bus Terminals/ Ship Terminals / reputed Malls/ Residential/ commercial building and Offices.</p> <p>The work should have been executed for Govt. / PSUs / Telecom Service Providers / IT Infrastructure Providers.</p>
<p>Period of Maintenance: (SCC Clause 24)</p>	<p>12 months from the date of passing of the certificate of completion/Professional Acceptance Certificate (PAC).</p>
<p>Maintenance Supervision: (SCC Clause 26.3)</p>	<p>The contractor shall be responsible for proper maintenance supervision of work for a period of 12 months from the date of issue of Provisional Acceptance Certificate (PAC) of each section/block section.</p>
<p>Warranty : (SCC Clause 29)</p>	<p>All materials supplied/work done by the contractor shall be guaranteed against the defects for a period of 12 months from the date of issue of Provisional Acceptance Certificate (PAC).</p>
<p>Security Deposit: (GCC Clause 16.2, Chapter –3,Section-I, Part I)</p>	<p>Security deposit should be 5% of contract value.</p>
<p>Contract Performance Guarantee: (SCC-Clause 3, Chapter –4, Section-I)</p>	<p>Contract Performance Guarantee should be 5% of Contract value.</p>

SECTION-I

CHAPTER-6

FORMS OF TENDER

SECTION - I

CHAPTER - 6

FORMS OF TENDER

Form No. 1	:	Offer Letter
Form No. 2	:	Qualifying Criteria / User's Certificate
Form No. 3	:	Agreement
Form No. 4	:	Guarantee Bond for Security Deposit
Form No. 5	:	Statement of Deviations
Form No. 6	:	Standing Indemnity Bond for 'On Account' Payments and Stores supplied by RailTel
Form No. 7	:	System Performance Guarantee
Form No. 8	:	Not used
Form No. 9	:	Work in Hand
Form No. 10	:	Not used
Form No. 11	:	Extension of period of completion of work on account of contractor
Form No. 12	:	Not used
Form No. 13	:	Qualification Experience
Form No. 14	:	Guarantee Bond against 'On Account Payments'
Annexure – 1	:	List of Materials to be supplied by Railtel

OFFER LETTER

To
RailTel Corporation of India Limited,
6th floor, Block-III, Delhi IT Park,
Shastri Park,
Delhi-110 053

I/We _____ have read the various conditions detailed in tender documents attached here to and hereby agree to ABIDE BY THE SAID CONDITIONS. I/We also agree to keep this tender open for acceptance for a period of 30 days from the date fixed for opening the same and in default thereof, I/We will be liable for forfeiture of my/our Earnest Money. I/We offer to do the work of **“Supply & Laying of OFC, HDPE Duct, Power Cable, etc. for providing WiFi Services at 10 Nos. Railway Stations of Chandigarh Territory of Northern Region.”** at the rates quoted in the attached schedules and hereby bind myself/ourselves to complete the work within 180 Days from the date of issue of Letter of Acceptance of the tender. I/We also hereby agree to abide by the various Conditions of Contract and to carry out the work according to the Specifications for materials and works laid down by the RailTel for the present contract.

2. A sum of Rs 1,90,000/- (Rupees One Lac Ninety Thousand only) as a Account Payee Demand Draft No. _____ dated _____ issued by _____ is herewith forwarded as “Earnest Money”. The full value of Earnest Money shall stand forfeited without prejudice to any other rights or remedies if,

I/We do not execute the contract agreement within 15 days after receipt of notice issued by the RailTel that such documents are ready or,

I/We do not commence the work within 15 days after receipt of orders to that effect.

Until a formal agreement is prepared and executed the acceptance of this tender shall constitute a binding contract between us subject to modifications, as may be mutually agreed to between us and indicated in the “Letter of Acceptance” of my/our offer for this work.

SIGNATURE OF CONTRACTOR (S)

Date

SIGNATURE OF WITNESS

CONTRACTOR (S) ADDRESS

1.

2.

ACCEPTENCE OF TENDERS

I accept the tender as above and agree to pay the rate as entered in Schedule of Requirements.

WITNESS

For and on behalf of

RailTel Corporation of India Limited,
N.Region, Delhi-110053

Date



QUALIFYING CRITERIA

USER'S CERTIFICATE

Name of the Firm

Contract No. & date

Scope of Work

Contract Amount (in Indian Rupees)

Completion Period as per original contract

Completion Period with extension

Data of Commencement

Actual date of Successful Completion

Name:

Dated:

Designation:

Signature of the Contractor with

Company Seal

Note: The relevant User's certificate to be attached.



AGREEMENT

(CA No.)

This AGREEMENT is made at Delhi on this _____ day of _____ two thousand and Nine by and between RailTel Corporation of India Limited (A Govt. of India Undertaking) having its Registered & Regional office at 6th Floor, Block-III, Delhi IT Park, Shastri Park, Delhi-110053, acting in the premises through ED/Northern Region (hereinafter referred to as 'RailTel', which expression should unless repugnant to the context or meaning thereof include its successors and permitted assigns) of the one part;

And _____ having its registered office at _____ acting in the premises through..... (hereafter referred to as "Contractor", which expression should unless repugnant to the context or meaning thereof include its successor and permitted assigns) of the other part.

Whereas in response to a call for Tender by RailTel for the work of "....." for RailTel Corporation of India Limited as per tender papers at Annexure 'A' read with Corrigendum..... issued by RailTel hereto, the Contractor has submitted a Tender as per Annexure 'B' hereto

AND WHEREAS the said Tender of the Contractor has been accepted for the work of "....." for RailTel Corporation of India Limited as per copy of Letter of Acceptance of Tender No. _____ dated _____ complete with enclosures at the accepted rates and agreed deviations from tender papers as per Annexure-C hereto at contract value of Rs. _____ (Rupees _____ Only) duly accepted by the contractor.

Now this agreement witnesses that in consideration of the premises and the payment to be made by the Purchaser (RailTel) to the Contractor provided for herein, the Contractor shall supply all equipment and materials and execute and perform all works for which the said Tender of the Contractor has been accepted strictly according to the various provisions in Annexure 'B' and 'C' hereto and upon such supply, execute and performance to the satisfaction of the purchaser (RailTel) and the purchaser (RailTel) shall pay to the Contractor at the rates accepted as per the said Annexure 'C' and in terms of the provisions therein.

IN WITNESS whereof both the parties have hereunto set and subscribed their respective hands and/or seals on the day and year respectively mentioned against their respective signatures.

Signed and delivered by Shri _____ for and on behalf of RailTel Corporation of India Ltd.

The contract within named in the presence of :

1. Signatures
Date
Name in Block Capitals
Address:

2. Signatures

Date
Name in Block Capitals
Address:

Signed and delivered by Shri. _____ for and on behalf of

The contractor within named in the presence of :

1. Signatures
Date
Name in Block Capitals
Address:
2. Signature
Date
Name in Block Capitals
Address:

Annexure 'A' :Tender Paper No..... with corrigendum, if any.
Annexure 'B' :Firm's offer.
Annexure 'C' :Letter of Acceptance No..... with all enclosures.
Annexure 'D' :Copy of Contract Performance Guarantee



CONTRACT PERFORMANCE GUARANTEE BOND

(On Stamp Paper of Rs one hundred)

(To be used by approved Scheduled Banks)

In consideration of the RailTel Corporation of India Limited, Northern Region, 6th floor, Block-III, Delhi IT Park, Shastri Park, Delhi-110 053 (Herein after called the RailTel) having agreed to exempt (Hereinafter called “the said Contractor(s)”) from the demand, under the terms and conditions of an Agreement No. dated made between RailTel Corporation of India Limited and for (hereinafter called “the said Agreement”) of security deposit for the due fulfillment by the said Contractor (s) of the terms and conditions contained in the said Agreement, on production of a Bank Guarantee for Rs. (Rs. only). We, (indicate the name of the Bank) hereinafter referred to as “the Bank”) at the request of Contractor(s) do hereby undertake to pay the RailTel an amount not exceeding Rs. against any loss or damage caused to or suffered or would be caused to or suffered by the RailTel by reason of any breach by the said Contractor(s) of any of the terms or conditions contained in the said Agreement.

We,(name of Bank) do hereby undertake to pay the amounts due and payable under this Guarantee without any demur, merely on demand from the RailTel stating that the amount as claimed is due by way of loss or damage caused to or would be caused to or suffered by the RailTel by reason of breach by the said Contractor(s) of any of terms or conditions contained in the said Agreement or by reason of the Contractor(s) failure to perform the said Agreement. Any such demand made on the Bank shall be conclusive as regards the amount due and payable by the Bank under this guarantee. However, our liability under this guarantee shall be restricted to an amount not exceeding Rs.only.

We,(name of bank) undertake to pay to the RailTel any money so demanded notwithstanding any dispute or disputes raised by the Contractor(s) / Supplier(s) in any suit or proceedings pending before any court or Tribunal relating thereto our liability under this present being, absolute and unequivocal.

The payment so made by us under this Bond shall be a valid discharge of our liability for payment thereunder and the Contractor(s) / Supplier(s) shall have no claim against us for making such payment.

We,(name of bank) further agree that the Guarantee herein contained shall remain in full force and effect during the period that would be taken for the performance of the said Agreement and that it shall continue to be enforceable till all the dues of the RailTel under or by virtue of the said Agreement have been fully paid and its claims satisfied or discharged or till RailTel certifies that the terms and conditions of the said Agreement have been fully and properly carried out by the said Contractor(s) and accordingly discharges this Guarantee. Unless a demand or claim under the Guarantee is made on us in writing on or before the We shall be discharged from all liability under this Guarantee thereafter.

We,.....(name of bank) further agree with the RailTel that the RailTel shall have the fullest liberty without our consent and without affecting in any manner our obligations hereunder to vary any of the terms and conditions of the Agreement or to extend time or to postpone for any time or from time to time any of the powers exercisable by the RailTel against the said contractor(s) and to forbear or enforce any of the

terms and conditions relating to the said Agreement and we shall not be relieved from our liability by reason of any such variation, or extension to the said Contractor(s) or for any forbearance, act or omission on the part of RailTel or any indulgence by the RailTel to the said Contractor(s) or by any such matter or thing whatsoever which under the law relating to sureties would, but for this provision, have affect of so relieving us.

This Guarantee will not be discharged due to the change in the Constitution of the Bank or the Contractor(s)/ Supplier(s).

We (the name of Bank) lastly undertake not to revoke this Guarantee during its currency except with the previous consent of the RailTel in writing.

Dated theday of 2016

for
(indicate the name of the Bank)

Witness

Signature
Name

Signature
Name

NOTE: The Guarantee shall be valid for a period of four months after the expiry of the warranty period of the equipment as per Clause 29 Special Condition of the Contract (SCC).



STATEMENT OF DEVIATIONS**(PROFORMA FOR STATEMENT OF DEVIATIONS)**

1. The following are the particulars of deviations from Preamble, requirements of the Instructions to Tenderers and Conditions of Tendering and Special conditions of Contract (Section -I):

Preamble (Chapter 2)

Clause	Deviation	Remarks (Including Justification)
--------	-----------	--------------------------------------

Instructions to Tenderers and Conditions of Tendering (Chapter 3)

Clause	Deviation	Remarks (Including Justification)
--------	-----------	--------------------------------------

Special Conditions of Contract (Chapter 4)

Clause	Deviation	Remarks (Including Justification)
--------	-----------	--------------------------------------

2. The following are the particulars of deviations from requirements of the **Technical specifications (Section -II)**

Chapter	Clause	Deviation	Remarks (Including Justification)
---------	--------	-----------	--------------------------------------

Note: Where there is no deviation, the statement should be returned duly signed with an endorsement indicating “**no deviations**”.

SIGNATURE AND SEAL OF THE
MANUFACTURER / TENDERER

Form No. 6

STANDING INDEMNITY BOND

(For On Account Payments and Stores supplied by RailTel)

(On Stamp paper of Requisite Value)

We, _____ hereby undertake that we hold at our Stores Depot/s at _____ for and on behalf of RailTel Corporation of India Limited in the premises through Regional General Manager/N R or his successor hereinafter referred to as "the Purchaser" all materials for which 'On Account' payments have been made to us against the Contract for ----- vide letter of Acceptance of Tender No. _____ and the materials handed over to us by the Purchaser for all purpose of execution of the said Contract, until such time the materials are duly erected or otherwise handed over to him.

We shall be entirely responsible for the safe custody and protection of said materials against all risk till they are duly delivered as erected equipment to the purchaser or as he may direct otherwise and shall indemnify the Purchaser against any loss, damage or deterioration whatsoever in respect of the said materials while in our possession and against disposal of surplus materials. The said materials shall at all times be open to inspection by any engineer authorized by the Regional General Manager / N R.(whose address will be intimated in due course).

Should any loss, damage or deterioration of materials occur or surplus materials disposed off and refund becomes due, the purchaser shall be entitled to recover from us the full cost as per prices included in the Contract (as applicable) and also compensation for such loss or damage, if any, alongwith the amount to be refunded without prejudice to any other remedies available to his by deduction from any sum due or any sum which at any time hereafter becomes due to us under the said or any other Contract.

Dated this _____ day of _____ 2016
for and on behalf of

(Contractor)

Signature of witness

Name and witness in Block letters

Address



Form No. 7

SYSTEM PERFORMANCE GUARANTEE

(PROFORMA FOR THE SYSTEM PERFORMANCE GUARANTEE)

To
The Regional General Manager / Northern Region

I / We Hereby guarantee that the design on the basis of which we have submitted our tender no. has been carefully made to conform to the end objectives in the tender documents and to technical specification therein. We further guarantee that in the event of the performance of the system, when installed, not complying with the end objectives or with the specifications contained in the tender documents, we shall provide further inputs to enable the RailTel to realize the end objectives contained in these documents without any additional payment for any additional equipment which may be required in this regard. We further guarantee that all the expenses for providing the additional inputs under the System Guarantee will be borne by us. We further guarantee that these additional inputs will be provided by us to make the system workable within 1 month from the date on which this guarantee is invoked by the Purchaser. The guarantee is valid for four months beyond the warranty period.

(Signature of Firm's Authorized Officer)
Seal

Signature of witness:

.....

.....



WORKS IN HAND

S.N	System and Name of Project	Party's address for whom the work is being done	Total value of contract	Schedule period of execution (in months)	%age progress in terms of works done	Likely date of completion	No. of Extensions Granted	Payments received till date	Remarks



EXTENSION OF PERIOD OF COMPLETION OF WORK

No. _____ Date: _____

To
.....
.....

Sub: (i) Name of Work
(ii) Acceptance Letter No.
(iii) Agreement No.

Ref:(Quote specific application of the Contractor for extension to date, if received).

Dear Sir,

The stipulated date for completion of the work mentioned above is
From the progress made so far and the present rate of progress, it is unlikely that the work will be completed by the above date (or) However, the work was not completed on this date.

Expecting that you may be able to complete the work if some time is given by that Regional General Manager/N.Region, RailTel Corporation of India Limited, Delhi, although not bound to do so, hereby extends the time for completion from to

* In consideration of the circumstances explained in your letter of request RailTel has extended the completion period by Days without any liquidated damages. Please ensure the completion and commissioning of the project well within the extended period.

* Please note that an amount equal to 0.5 % of the total value of the contract per week or part thereof (rounded off to the nearest whole number) subject to a maximum of 10% of the total contract value of the works as a recovery for delay in the completion of the work after the expiry of (1) will be recovered from as mentioned in clause 35 chapter IV of the special conditions of contract for the extended period notwithstanding the grant of this extension. You may proceed with the work accordingly.

The above extension of the completion date will also be subject to the further condition that no increase in rates on any account will be payable to you.

Please intimate within a week of the receipt of this letter your acceptance of the extension on the conditions stated above.

Please note that in the event of declining to accept the extension on the above said conditions or, in the event of your failure after accepting or acting up to this extension to complete the work by (2) (here mention the extended date), further action will be taken in terms of relevant clause of special conditions of contract.

Yours faithfully,

for & on behalf of RailTel Corporation of India Limited

Note:

- (1) Give here the stipulated date for completion without any penalty fixed earlier.
 - (2) Here mention the extended date.
- * Strike out one of the clauses as applicable.



Form No. 13

QUALIFICATION EXPERIENCE

USER's CERTIFICATE

Name of the Firm

Contract No. & date

Scope of Work

Contract Amount (in Indian Rupees)

Completion Period as per original contract

Completion Period with extension

Data of Commencement

Actual date of Successful Completion

Name:

Dated:

Designation:

Signature of the Contractor with

Company Seal

Note: The relevant User's certificate to be attached.

GUARANTEE BOND AGAINST 'ON ACCOUNT' PAYMENTS

(On Stamp paper of requisite value)
(To be used by approved Scheduled Banks)

In consideration of the RailTel Corporation of India Limited (hereinafter called "the RailTel") having agreed to exempt(hereinafter called " the said Contractor(s)") from the demand, under the terms and conditions of an Agreement No.dated.....made between and for (hereinafter called " the said Agreement") of on Account Payment for the due fulfillment by the said contractor(s) of the terms and conditions contained in the said Agreement, or production of a Bank Guarantee for Rs. (Rs. only). We,(indicate the name of the Bank) hereinafter referred to as " the Bank") at the request of Contractor(s) do hereby undertake to pay the government an amount not exceeding Rs. Against any loss or damage caused to or suffered or would be caused to or suffered by the RailTel by reason of any breach by the said Contractor(s) of any of the terms or conditions contained in the said Agreement.

We, Bank do hereby undertake to pay the amount due and payable under this Guarantee without any demur, merely on demand from the RailTel stating that the amount is claimed is due by way of loss or damage caused to or would be caused to or suffered by the RailTel by reason of breach by the said Contractor(s) of any of terms or conditions contained in the said Agreement or by reason of the Contractor(s) failure to perform the said Agreement. Any such demand made on the Bank shall be conclusive as regards the amount due and payable by the Bank under this guarantee. However, our liability under this guarantee shall be restricted to an amount not exceeding Rs.

We, Bank undertake to pay to the RailTel any money so demanded notwithstanding any dispute or disputes raised by the Contractor(s) / Supplier(s) in any suit or proceedings pending before any court or Tribunal relating thereto our liability under this present being, absolute and unequivocal.

The payment so made by us under this Bond shall be a valid discharge of our liability for payment there under and the Contractor(s) / Supplier(s) shall have no claim against us for making such payment.

We, Bank further agree that the Guarantee herein contained shall remain in full force and effect during the period that would be taken for the performance of the said Agreement and that it shall continue to be enforceable till all the dues of the RailTel under or by virtue of the said Agreement have been fully paid and its claims satisfied or discharged or till RailTel certifies that the terms and conditions of the said Agreement have been fully and properly carried out by the said Contractor(s) and accordingly discharges this Guarantee. Unless a demand or claim under the Guarantee is made on us in writing on or before the (1) We shall be discharged from all liability under this Guarantee thereafter.

We,(indicate the name of Bank)..... further agree with the RailTel that the government shall have the fullest liberty without our consent and without affecting in any manner our obligations hereunder to vary any of the terms and conditions of the Agreement or to extend time of to postpone for any time or from time to time any of the powers exercisable by the RailTel against the said contractor(s) and to forbear or enforce any of the terms and conditions relating to the said Agreement and we shall not be relieved from our liability by reason of any such variation, or extension to the said Contractor(s) or for any forbearance, act or omission on the part of RailTel or any indulgence by the RailTel to the said Contractor(s) or by any such matter or thing whatsoever which under the law relating to sureties would, but for this provision, have affect of so relieving us.

This Guarantee will not be discharged due to the change in the Constitution of the Bank or the Contractor(s) Supplier(s).

We, (Indicate the name of Bank) lastly undertake not to revoke this Guarantee during its currency except with the previous consent of the RailTel in writing.

Dated the day of 2016
for
(Indicate the name of the Bank)

- Witness
1. Signature
 Name

 2. Signature
 Name

Note: The Guarantee shall be valid for four months beyond the date of completion of work.



Section - I

Annexure - 1

List of materials to be supplied by RaiTel to the contractor:

S.No.	Name of materials
1.	HDPE Duct (33/40 mm dia) with accessories

Note: The materials shall be supplied from the store of Site Engineer of RailTel.

No extra transportation cost shall be paid by RailTel to contractor.



Section - I

Chapter - 7

**SCHEDULE
OF
REQUIREMENTS
(SOR)**



Schedule of Requirements

Name of the Work : “Supply & Laying of OFC, HDPE Duct, Power Cable, etc. for providing WiFi Services at 10 Nos. Railway Stations of Chandigarh Territory of Northern Region.”					
Tender No. RailTel/Tender/OT/RO/WiFi work/CDG/10 Stn/2015-16/23					
Schedule of Requirements					
SN	Description	Unit	Total Qty.	Rate/Unit (Rs.)	Amount
1	Supply of 24 core metal strenghtened outdoor unarmored OFC	Mtr	23595	30	707850
2	Supply of 6 core metal strenghtened outdoor unarmored OFC	Mtr.	27720	11.07	306860.4
3	Supply and provision of OFC joint closure including splicing (24 fibers) the Joint enclosure shall be TVSE/Reychem/FOSC/ Roxtec/3M make or similar	Nos	10	4000	40000
4	Supply of joint closure for 06 fiber OFC	No.	60	44.96	2697.6
5	Splicing of fiber of 24F OFC (in Joint enclosures or FMS as per the site requirement)	No.	2688	101.16	271918.08
6	Splicing of fiber of 6F OFC (in Joint enclosures or FMS complete as per the site requirement)	No.	1656	101.16	167520.96
7	Blowing & Drawing of OFC Cable in PVC Conduit pipe {(already installed (in electrical work))}	Mtr	27720	7	194040
8	Supply & installation of Conical Manhole	Nos.	10	10208	102080
9	Supply & Installation of RCC Chambers	No.	20	3200	64000
10	Supply & Fixing of Cable Route Marker as per Drawings	No.	51	250	12750
11	Supply and installation of GI Pipe 40 / 50 / 75 mm (IS 1239 medium gauge) as per site requirements	Mtr	1000	490	490000
12	Trenching by HDD Machine at depth 1.65 Mtr. for Road corssing	Mtr	4400	262.50	1155000
13	Concreting in Rocky areas for OFC protection and to keep the route marker in position	Cu.mtr	30	3082	92460
14	Excavation of open trenches upto depth of 1200mm of appropriate with all the bottom for all types of soil except in hard and rcoky soil.	Mtr	11050	39.99	441889.50
15	Laying of HDPE duct in the Trenches and in protective works already provided.	Mtr	15450	4.50	69525
16	Blowing & Drawing of OFC Cable in HDPE duct.	Mtr	23595	4.961	117054.795
17	Final Testing & Commissioning	Mtr	51315	0.8121	41672.9115
18	Supply of PVC insulated 3 Core 6 Sqmm , 1.1 KV grade outdoor strengthened Copper cable for UPS supply distribution (as per BIS/ISI standards)	Mtr	2700	157.5	425250
19	Supply of PVC insulated 3 Core 4 Sqmm , 12 AWG , 1.1 KV grade outdoor strengthened Copper cable for UPS supply distribution (as per BIS/ISI standards)	Mtr	22200	135	2997000
20	Providing telecom maintenance free earthing as per the drawing attached & extension as per site engineer	Nos.	10	38500	385000

21	Supply of 25 mm PVC Conduit Pipe (as per BIS/ISI standards) & Installation, Clamping of the same on wall, pole etc. with required clamps & all other installation material as required as per site requirement	Mtr	24300	46.06	1119258
22	Blowing & Drawing of Ethernet Cable in PVC Conduit pipe	Mtr	3600	5.82	20952.00
23	Supply & Installation of 10A/DP MCB as per ISI Standard in suitable PVC/Metallic Box	Nos.	36	185	6660
24	Laying of Power Cable in PVC Conduit pipe	Mtr	24900	4	99600
25	Fixing or mounting of 6U/9U size Rack at suitable height on Wall, Pole. All sorts of Angles, Nuts, Bolts, Clamps and other accessories required for installation to be supplied by Contractor (rack will be supplied by RailTel)	Nos.	128	1000	128000
26	Fixing or mounting of UPS in 9U size Rack or outside on wall /pole. All sorts of Angles, Nuts, Bolts, Clamps and other accessories required for installation to be supplied by Contractor (UPS will be supplied by RailTel)	Nos.	36	500	18000
TOTAL					9477039

Amount in Words: Ninety Four Lacs Seventy Seven Thousand Thirty Nine Only

Tenderer's offer.: " I/We hereby offer to do the work at following rates

In Figure	% Above/Below the Schedule of rates
In Words	% Above/Below the Schedule of rates

Note:- Above quoted rates are including all type of applicable taxes. It is mandatory for the tenderers to give tax break up in table given below.

Tax Break Up

Sr. No.	Tax Name	Rate of tax (%)

The requisite EMD for an amount of Rs. _____ submitted vide DD No.

_____ dated _____ drawn on _____ bank.

Signature of Tenderer with Seal



SECTION – II

TECHNICAL REQUIREMENTS & SUPPLEMENT

INDEX

<u>Chapter No.</u>	<u>Content</u>
1.	Precutions to be taken in 25 KVA A.C Traction Area.
2.	Preperation of as built route plan.
3.	Technical specification for Trenching & Laying of OFC.
4.	Specification for Jointing & Termination of OFC.
5.	Technical specification for provision of Earthing
6.	Jointing of 6 Quad Telecom Cable & Acceptance Test
7.	List of Address for specification.



SECTION - II

CHAPTER - 1

PRECAUTIONS TO BE TAKEN IN 25 KV A.C. TRACTION AREA:

1.1 GENERAL

Any Telecommunication circuits in the vicinity of AC Traction running parallel to 25 KV lines are liable to be affected by AC induced voltage. Therefore precautions should be taken to eliminate the possibility of induced voltage affecting equipment and humans.

Crossing of track, if any, should be negotiated by underground cables running at right angles to the track as far as practicable.

Special protective measures (viz. provision of G.D tubes, fuses and earthing etc) are required to be taken for telecommunication lines entering 25 KV sub station /switching posts.

For the human safety considerations the safe working voltages should be 60 V under normal conditions and 150 V with special precautions and 430 V under fault conditions.

Instructions for protection of railway staff/working personals on signaling and telecommunications installations on 25 kV AC traction shall be strictly adhered to. Precautions are required to be taken on account of following,

- i) Proximity of live conductor.
- ii) Pressure of return current in Rails.
- iii) Induction in all metallic bodies situated closed to over head equipment.



SECTION - II

CHAPTER - 2

PREPARATION OF AS-BUILT ROUTE PLANS

2.0 SCOPE:

The scope of this is to prepare a final set of As-Built drawings of route plans, based on the actual cable route (which in turn shall be based on a preliminary & approved drawings of route plans, already supplied to the contractor).

2.1 Points to be taken care of for laying the OFC cable:

- 2.1.1 Avoid underground structures, signaling cable, power cables and pipe lines etc.
- 2.1.2 Avoid rodent/termite infested or infected side of the alignment.
- 2.1.3 Offset of the cable trench from the central line of the track such as having burrows.
- 2.1.4. Avoid proximity to chemical, paper and such other industries which discharge chemically active affluent.
- 2.1.5 Avoiding areas prone to water logging.
- 2.1.6 Avoiding large rock cutting/thick jungles and areas difficult to approach etc. The orientation of the route (left or right side of the track in the sections) to be decided on following:-

That side of main line, which is away from coastal side, other cables such as signaling and power.

That side which is likely to involve least track crossings and likely to be more convenient for crossing the track, bridges culverts etc.

Avoid built up areas including those area where buildings etc. are likely to come up in future.

For the straight runs as far as possible a separation of 10 Meter should be kept from the nearest track. This is as per CCITT recommendation K.8.

As a rule a minimum distance of 5.75 M should be maintained between the OHE masts and the cable. In Yards etc. where observance of this rule may be difficult, a minimum distance of 3 Meter should be maintained. In exceptional cases where the cable trench depth is less than 0.5 M the lateral distance may be reduced to 1 M.

Make the route of OFC cable within 1 meter of Railway boundary normally.

2.2 As-Built Cable Route plan.

Based on above actual route, the as-built cable route plan should be prepared:

- 2.2.1 The name of the location should be put in the 'LOC' column and the change in the 'CH' column. At every 10 cm. the Km. post number should be written and its exact equivalent change entered in the

'CH' column. The name of station should be shown against the location of the Station Master 's Office.

2.2.2 Based on the route, the serial number and the length of culverts, bridges and level crossings should be marked on the 'Track Line' of the cable route plan.

2.2.3 The actual measurement of the separation distance from the central line of the track (the adjacent main line) is to be shown. This is to be compiled on the 1 Km charts.
The termination plan & locations of joint enclosures of OFC to be shown.

2.3 Preparation of Drawings

All the plans and drawings shall be neatly prepared using Computer Aided Design System & plotter etc. The drawings shall be in A3 size & suitably filed for ease of handling.
Further, a soft copy of Auto-CAD drawings in CD shall be submitted.

2.4 Information in Cable route plan:-

The cable route plan shall contain following information:-

2.4.1 Whether the cable route is on the **up** or **down** side of the Railway Tracks.

Exact locations and lengths where the cable is laid in RCC/DWC/G.I. pipes/ troughs and under the bed on culverts.

Location of track crossing and the number of tracks being crossed.

Location of road crossing and the no. of RCC/DWC/GI pipes provided.

Locations and length for protection of cable in rocky area and platform cutting etc.

Locations of Pull Chambers/Joint Pits.

2.5 DELETED.

2.6 DELETED

2.7 Guidelines for finalization of cable route plan :

2.7.1 The following are the guidelines for preparation of the cable route plan:
Prepare the "1 Km charts" as explained above and enter the relevant changes and details in the "1 Km charts" based on the latest copy of approved OHE/Overhead plan supplied to him by the engineer.

2.7.2 Actual measurement by 30 M steel tape or chain along the route is necessary only in case of important locations, to be termed as "special terrains", for example, approach to repeater station/cable hut, long bridges, big yards, sharp diversions in the cable route from its parallel course along the main railway tracks due to obstruction, cuttings etc.

2.7.3 Inspect and decide the portions of route falling in category of "special terrains" stated in para 2.7.2 above, i.e. where actual longitudinal measurement is necessary.

2.7.4 The remaining portions of the route, i.e. other than the portion decided as "special terrain" as per para 2.7.2 above are to be termed as "straight runs". Actual chaining along the route is not

necessary for such "straight runs" and these can be marked on the "1 Km. charts" by taking chainages from the OHE/ Overhead alignment plan.

- 2.7.5 The cable route should be started from a repeater/ cable hut/ station. Actual measurement along the route should be done by means of a 30 M steel tape for a few drum lengths up to a convenient point along the main line where from the distances along the route may be reckoned from the OHE/ Overhead alignment Plan. A termination allowance of actual length (prescribed 5M) of cable inside the repeater station/cable hut building should be, in addition to a length of about 10 M (actual length), kept in a pit just outside the building.
- 2.7.6 It should be ensured that both "special terrains" and "straight runs" should consist of full drum lengths, so that the position of joints (other than T-Joint) is fixed without difficulty in both cases.
- 2.7.7 Actual measurements of the separation distance should be done from the centre line of the reference track. In case of 'Special terrains' the separation distance at some points on the route may also have to be reckoned from some other permanent structures depending upon the site conditions.
- 2.7.8 Once the cables are laid, the chain ages at diversions, crossings, approaches of bridges, Jointing Chambers and Joints/Extra lengths of Optical fibre cables should be clearly marked on cable route plan.

2.8 Length of Optical Fibre cables: -

The approximate cable length is worked out on following basis to arrive at the location of the straight joints: -

Extra length for track crossing including 2.5 meter loop on each side.

Extra length on Approach/crossing of the bridges and culverts as per measurement in the detailed survey.

10 meter of cable to be kept on either side of major steel bridges and 5 meters on minor bridges.

At every Joint Pit a loop of 10 meters on either side of the joint and a loop of 15 meters in the Pull Chambers without joint, should be kept. In cable hut a loop of 10 meters should be kept in the cable pit.

2.9 Protective works for Cable/ Ducts:-

- 2.9.1 For building, masonry platforms, culverts, crossing of tracks, level crossings and roads etc. special protection for the cables are required. Some of the methods adopted for different types of protective works are specified in the following drawings:-

For Girder bridges M.S. Troughing Drg. S&T/RE/78/2/76 Page 1 & 2 and RE/42/172. (P-160 & 163).

For cable entries to Cabins, ASM's Offices etc. through HDPE pipe Drg.No. RE/S&T/ALD/SK/161/81 (P-174).

For unconsolidated embankments Shoring for the cable trench as per Drg.No. RDSO/TC/35003. (P-168).

For laying cables over the culverts in DWC pipes Drg. No. RE/S&T/ALD/SK/160/81. (P-162).

For laying cables over arch bridges brick channeling Drg. No. RE/S&T/ALD/SK/162/81. (P-173).

For route over rocky area through chase Drg.No. RE/S&T/SK/303/85 with Alteration 'A'. (P-167).

For routes under bed of culverts in DWC pipes Drg.No. RE/S&T/ALD/SK/184/81. (P-165).

For cable laying under railway track Drg. RE/S&T/ALD/SK/159/81 (P-169).

For cable laying under road drg. No. RE/S&T/ALD/SK/497/2000 (P-157)

For Stone/RCC cable route marker drg no. RCIL/NR/01 (P-172).

Note1: In non-RE area, wherever distances are reckoned with reference to overhead alignment, the distances from the nearest KM-post provided along the track, may also be mentioned.

Note 2: If any of the above-mentioned drawings are illegible or not clear, the clarifications may be sought from the office of Regional General Manager, RailTel/Northern Region.



SECTION - II
CHAPTER - 3

TECHNICAL SPECIFICATION AND INSTRUCTIONS FOR TRENCHING AND LAYING OF OPTICAL FIBRE CABLE AND TELECOM CABLE:

3.1 SCOPE:

This chapter deals with the specifications under which the various work for trenching & laying of optical fibre cable coming under the purview of the contract are to be executed by the contractor.

3.2.1 SUPPLY OF ROUTE PLAN:

Approved Cable Route plan and jointing schedule for mid section splicing of cable will be prepared and supplied by the RailTel This shall give a preliminary idea of the number & locations and the quantities and type of various equipment to be fixed, wired and commissioned.

3.3 INSTRUCTIONS FOR EXCAVATION & BACK FILLING OF TRENCHES

3.3.1 The Representative of Engineer In-charge of the work will mark the route of the cable in white chalk or lime as per the tapping and route plan and the instructions given to him by the Engineer, notwithstanding the cable route shown in the tapping and route plan to meet the requirement of local conditions at site, if any and as required shall be taken by the contractor to be final. The contractor shall be present at the time of marking and he shall furnish to the Engineer's representative required quantities of lime, rope, labour etc. for carrying out this work. The marking will be given on the track side of the trench at a distance approximately one meter away from the centre line of the trench. In the difficult terrains such as water-logged areas, the position of the cable route will be specified by off sets from the centre line of the nearest track.

3.3.2 Trenches for Telecom cable shall be dug to a depth of 1.0 meters. The width of the trench shall be adequate at the bottom to accommodate cables and their protection. Normally width of approx. 250-300mm at the bottom is sufficient. In places where underground pipes, electric main etc. come in the way, trenches deeper than one meter shall be dug as necessary and RCC/GI/DWC pipes shall be placed to protect the optical fibre cables.

3.3.3 Metalled, macadamized, concrete and stone paved roads shall also be cut to a depth of 1.0 meter. The cable shall be laid through RCC/GI/DWC pipe as per drg. at Annexure 3.2. **The road surface shall be restored to original.**

3.3.4 Wherever it is not possible to dig trench up to 1.0 meter depth due to site conditions, specific approval of site engineer / engineer's representative should be taken before digging trenches of lesser depth. Similarly where digging of trench for more than 1 meter depth is required due to site conditions, specific approval of site engineer / engineer's representative should be taken before commencing the work. In both cases prorata payments for the items of schedule shall be made.

3.3.5 The bottom of the trench where the cable is to be laid shall be free from any stones. The bottom of the trench shall be horizontal and shall in no case be undulating. When the cable bed changes from solid to soft surface or from the bridge to soft soil, tamped fill at the transition point shall be provided so that cable is not pressed against the edge of a hard surface.

3.3.6 The brick protection shall be provided, wherever required and instructed by the engineer-in-charge .The contractor shall arrange supply and distribution of second class bricks of standard size at site

along the excavated trenches and after uniformly covering the cable laid in the trenches by stone-free sieved soil up to 50 mm height above the cable, he shall arrange to place the bricks flat and position them breadth wise so that on an average 8/9 (eight/nine) bricks shall be laid in a meter length.

NOTE: In order to be certain that the full requirement of bricks has been arranged by the contractor for placing on the top of the cable to be laid on any day, he shall spread the bricks side by side on the top of the trenches before the depth of the trenches are inspected by the authorized representative.

- 3.3.7 The backfilling of trenches shall be done by tamping and consolidating the excavated soil in layers of 15-20 cm at a time. All the soil that is excavated shall be put back to the trench and care shall be taken in consolidation to ensure that the back filling does not suffer any sinkage in monsoon.
- 3.3.8 If under unavoidable circumstances, the excavation is to be done between the tracks or between OHE foundation and track, it shall be done to the full depth just before laying the cables and in the presence of the Engineer's representative so as to ensure the safety of train operations.
- 3.3.9 Wherever the Engineer's representative considers it necessary to adopt shoring, the Contractor will be required to adopt shoring for which the Contractor shall have sufficient quantities of shoring material on hand as per RDSO Drawing No. TC 35003 given at Annexure-3.3. The shoring shall invariably be carried out in case of loose soil or banks made of cinders and ashes.
- 3.3.10 Where the direction of the trench has to change, it should be done in a gentle curve of not less than one meter radius and not at sharp angles.
- 3.3.11 While crossing tracks and laying over bridges & culverts, the engineers representative shall be present. The date and time of such works shall be communicated to concerned telecom supervisor of the Railways and adequate precautions, as advised by them, have to be taken.

3.4 TRACK CROSSING

All cable crossings across railway tracks shall be done in G.I. pipes (100 mm), threading the cable through these pipes. The contractor shall do the trenching to the required depth wherever necessary such as approaches to track crossing and the length in between the adjacent tracks. Two nylon rope of suitable strength shall be threaded through G.I. pipes, one to pull the cable and one for future use. The arrangement of cable and G.I. Pipe trunking under Track crossings has been shown in Drg. No. RE/S&T/ALD/SK/159/81 given at Annexure-3.4.

3.5 ROAD CROSSING

- 3.5.1 When crossing road ways, it is necessary to lay the cables in such a manner as to avoid the necessity of handling the cable sharply and minimize excavation of road surface as far as possible. Where cable is laid in surfaced trunking, the trunking alignment should be curved down to the pipes and proper brick or concrete joint should be made between trunking and pipe.
- 3.5.2 The crossing of main roads often involves difficulties especially if traffic is heavy, precautions to avoid accidents to workmen, pedestrians and vehicles should be taken. On minor roads, which can be temporarily closed to traffic, it is possible to cross the entire width of the road and open up. Pipes should be installed quickly in the cutting which is then filled in there by reducing to a minimum time for which the road is closed.

3.5.3 Some roadways which are broad may be opened for half their width, allowing the other half for use of traffic. Pipes are laid trench filled in the first half and the other half opened up after the first half is opened for the traffic. Pipes laid in the second half is linked with those laid in the first half. G.I. pipes shall be used for road crossings. In all cases pipes should be laid at a depth of 1 meter, below the formation level or lower as may be required.

3.5.4 Whenever a cable is laid across an important road particularly one with a special surface it is necessary to provide for future expansion. The following methods may be adopted.

(a) Separate pipes shall be laid for separate cable/HDPE duct. Two length of G.I. wire 10 SWG shall be used as lead wire. Two such lengths of G.I. wire shall be laid through the pipe. One wire shall be used for leading in the cable & the other wire shall be kept with suitable overlay to enable cable pulled out at later stage, if required.

3.5.5 At busy road crossings, trenching should be done in nights with appropriate protection and road warnings to road users.

3.5.6 The tenderer shall be responsible for compliance to applicable laws of the land and registration/approval from statutory authority, if required.

3.6 CABLE OVER STEEL / GIRDER BRIDGES:

3.6.1 Separate DWC/GI pipe shall be provided on Girder Bridges to lay OFC.

3.6.2 The Fibre optic cable on steel girder bridges shall be laid inside RCC/GI/DWC pipe to be effectively secured as per the drawing and DWC duct at both ends of bridges shall be protected.

3.6.3 When laying cable on long bridges, the question of longitudinal expansion caused by temperature differences should be taken into consideration and suitable cable loops should be provided at the pillars of the bridge. The cable should also be laid sinuously inside the trough.

3.6.4 The laying of the cable on the bridges is to be done with much care and planning. It is necessary that the cable drum to be laid on the bridge is inspected and tested thoroughly so that damaged cable is not installed.

3.7 Cable over CULVERTS :

3.7.1 Wherever possible the cable shall be laid under the bed of the culvert through DWC/G.I./RCC pipes as per sketch No. RE/S&T/ALD/SK/184/81 (Annexure-2.9). Similar arrangement shall be provided for taking the cable in water logged areas and drains.

3.7.2 In case of wet culverts or unfriendly terrains where it is not possible to lay cable under the bed of culverts, the cables may be laid over the culvert in G.I.pipes as per Drg.No.RE/S&T/ALD/SK/160/81A (Annexure 3.8).

3.7.3 The protection of cable on approach to culverts shall be as per Drg. No. RE/S&T/ALD/SK /162/81(Annexure 2.7).

3.7.4 ARCH BRIDGES

The protection of cable on Arch Bridges and approach to bridges should be as per Drg.No. RE/S&T/ALD/SK/162/81 as given at Annexure-2.7.

3.8 LAYING CABLE IN SOLID AND ROCKY SOIL

- 3.8.1 If the terrain is rocky, it may not be possible to ensure normal dimensions of the trench. In such cases a chase is cut as shown in Drg. No.RE/S&T/ALD/SK/303/85, as given at Annexure-3.11. Sharp edges on the sides must be smoothed out and bottom of the chase should be levelled and the cable laid in sand or soft earth which should be filled and pressed down up to the step. A row of bricks should then be placed on the top and jointed with cement mortar.
- 3.8.2 In cases where the rock is not directly encountered, excavation to the desired depth shall be done. Payment for excavation shall be made on prorata basis on the accepted rates of item-1 of schedule of requirement.
- 3.8.3 In cases where excavation is possible up to 1000 mm no chase cutting shall be done. However the cable/HDPE duct shall be protected by providing second class bricks width wise on such lengths.

3.9 CABLES IN CONGESTED RESIDENTIAL AREAS AND MARSHY AREAS:

- 3.9.1 When laying the cable in residential sections, the cable should be specially protected on both sides up to a distance of about 300 meters beyond the building line. In such cases the cable should be protected by laying cable inside DWC/G.I./RCC pipes of 120/103 mm dia.
- 3.9.2 In marshy area where it is not possible to divert the cable route the cable shall be suitably laid and protected as per decision of Engineer depending on site condition, like laying cable in DWC/G.I./RCC pipes of 120/103 mm dia supported on Masonry Pillars/Iron channels etc.

3.10 LEADING OF CABLE IN MASONRY BUILDINGS

- 3.10.1 The cable will have to be led inside any masonry building such as Cable hut, ASM's room at a depth of 0.75 meters by cutting the masonry structure of the wall as per Drg.No. RE/S&T/ALD/SK/161/81 as given at Annexure- 3.12. After the cable has been led inside the masonry wall, the floor inside shall be duly repaired and plastered.

3.11 LAYING OF CABLE IN SPECIAL CASES:

3.11.1 Near Power Cable

When the proposed cable route comes across any other cable already laid, the contractor shall first report the fact to the Engineer. Should the cable be identified by the Engineer as a power cable (LT or HT), the trench shall be dug as far away from the route of the power cable as practicable.

3.11.2 Crossing of Optical Fibre Cable with another cable

Crossing of the Optical Fibre cable with another cable shall be avoided wherever possible. Where, however, this is not possible, the Optical Fibre cable shall be laid in cement or asbestos cement pipes. The length of the pipe to be provided on either side of the crossing shall be atleast one meter.

3.11.3 Laying other than optical fibre cables in the same Trench

No cable other than quad cable shall be laid in the trench made for the Optical Fibre cable. Even in such cases, both the cables are to be laid as per approved drawing. Where, however, exceptional circumstances exist, the optical fibre cable may be laid along with another cable in the same trench provided a specific permission of each such case is obtained in writing from Engineer. When optical fibre cable and L.T. power cable have to be laid in the same trench they shall be separated by placing a layer of second class bricks between them vertically (approx. 16 bricks/meter) or laid in RCC pipe.

3.11.4 Laying of cable through RCC/GI/DWC pipes

The cable shall be laid through RCC/GI/DWC pipes at the locations marked on the route plan and as advised by the Engineer or his representative.

For laying the cable through pipes galvanised steel wires of a cross section not less than 10 SWG shall be used as a lead wire. Two such lengths of wires shall be laid through the pipes, so that after the cable is threaded through the pipe, one lead wire is permanently left in the pipe with a suitable overlay at two ends, to enable the cable to be pulled out at a later stage if required to do so.

On arch bridges and culvert bridges the cables will be threaded through DWC pipes etc. While threading the cable through these pipes the Contractor shall do the trenching to the required depth wherever necessary for which no extra charge will be paid.

3.11.5 Laying cable near feeding post:

In the vicinity of feeding posts, as far as possible the cable shall be laid on the side of the track opposite to the feeding post. Further the Optical fibre cable shall be at least one metre away from any metallic part of the O.H.E. and other equipment at the sub station which is fixed on the ground and at least one metre away from the sub - station earthing. In addition, the cable shall be laid in RCC pipes 150 mm dia (standard 2 metre length) complete or capable of being split into two half as per specn. No. ISS-458 latest for a length of 300 metres on either side of the feeding point.

3.11.6 Running of cables at foundations others than OHE Masts and from pipe outlets.

Damages to cable is likely to occur if care is not taken in laying cable where the bed changes from solid support such as a foundation pipe or bridge to soft support such as soft soil. The cable must not press against the edge of the solid support. The soft soil near the edge must be tamped and the cable raised slightly.

3.11.7 Laying near oily surface

If during the excavation of trenches for laying cables, the Contractor or his representative notices the presence of oil or oily substance or any other chemical which is likely to cause the deterioration of the cable protective material he shall bring the matter to the notice of the Engineer or his representative and on the latter's decision he shall choose an alternative cable route or he shall protect the cable in such places in such manner as advised in writing by the Engineer or his representative. No additional charges are payable.

3.11.8 Special soil condition

Cable should not be run through abnormally high acidic or alkaline soil or through sewage. If this is unavoidable, special measures should be taken against corrosion as advised by the Engineer in Charge.

3.11.9 Provision of damage due to sharp edges

When cable are laid in trunking, care should be taken to see that no ballast or stones have been dropped inside the trunking and it should be cleared of all ballast and stones before the cover is secured. When the ends of covers are joined together with cement plaster, a piece of paper or wood should be placed under the joint to prevent the cement plaster from falling on the cables.

3.12 HANDLING OF CABLE DRUMS & PAYING OF CABLES:

- 3.12.1 While collecting OFC/HDPE from RailTel depot the contractor must ensure that the materials should be received in good condition. The drums shall be unloaded by the side of the Railway Track/Road from either a crane or any other suitable means very carefully so as not to cause any damage to the cable. The drums at site shall be protected until they are laid. The cable must be tested before and after laying.
- 3.12.2 On each drum there are two ends, A & B. The 'B' end of one cable length shall meet 'A' end of the next cable at a joint. The 'A' end shall be normally on the top unless indicated otherwise on a drum.
- 3.12.3 The drums shall always be kept upright, i.e. axle in parallel position to the base. The drums shall not be set by jerks but shall be handled slowly and with care. The walls of the drums should not be damaged while moving the drums if required for unrolling.
- 3.12.4 The drums shall normally be unrolled at the same place and the cable carried by workmen near the trench. The drums shall not be dragged in any case. But where drums of cable have to be moved, would always be rolled in the direction of the arrow, otherwise the coils tend to unwind and the cable may get battered. In case no direction arrow is marked on the drum, remove several battens and determine the direction in which the cable is coiled. The arrow should then be painted on the drum pointing in the opposite direction in which the upper cable end is coiled so that future handling of the cable drum is facilitated and then replace the battens carefully.
- 3.12.5 The drum should be properly mounted on jacks (or on a cable wheel) making sure that the spindle is large enough to carry the weight without bending and that it is laying horizontally in the bearings so as to prevent the drum creeping to one side or the other while it is rotating. Before attempting to pull off the cable, remove the end protection box attached to the flange of the drum and cut the security ropes so as to leave the cable free to move.
- 3.12.6 If a portion of the cable only is taken out from the cable drum, the battens should be immediately replaced to prevent damage to the balance of the cable. This is important.
- 3.12.7 The use of steel bars between the bolt heads to 'jump' or turn the drum around is dangerous to staff and likely to damage the drums. A better method is to use two steel plates with grease between them. By standing the drum on these greased plates, it can be easily elevated round to the desired position.
- 3.12.8 All care should be taken in handling cable drums with a view to ensure safety not only of the cables but also of the working party handling them. The man should not be allowed to brake the cable drum by standing in front but only from side.

3.12.9 Rewinding and Redrumming of cables.

- (a) If for any reason it is found necessary to rewind a cable on a drum, cable drum with a proper barrel diameter not less than of the original drum should be chosen.
- (b) The drums should be mounted on cable jacks during rewinding operations using proper size of spindles passed through the flange holes, which will not buckle under the lead. The cable should not be bent opposite to the set it is having already.
- (c) In the re-drumming operations, drums should be so turned that the cable passes from the bottom of the original set with as little gap as possible.
- (d) Replace all the lagging on the cable drum.

3.13 CABLE LAYING:

- 3.13.1 It is advisable to employ the same people at the same place or job while cable is being laid.
- 3.13.2 Before commencement of the laying of cable/HDPE duct, inspection of the trench and inspection of protection works should be carried out so as to ensure their conformity with the specification. The trench bottom should be clean, smooth and free of small stone. When the soil contains stone or pieces of rock and therefore cannot be raddled, sieved earth about 10 cm. thick should be used both for the bedding on which the cable is laid and for covering the cables.
- 3.13.3 The cable drum should be brought as close to the cable trench as possible. It should be lifted with the aid of cable jacks firmly mounted on a support of stone or wood. The spindle should be minimum of 55 mm diameter and have a clearance from ground by 5 to 10 cm.
- 3.13.4 Where necessary the cable drum may be placed at such a point so that 2/3 of the cable is laid directly in one direction and the balance in other direction. Care should be taken in such a case to see that there are no kinks or loops in the cable.
- 3.13.5 The wooden battens on the drums should be carefully removed shortly prior to laying and before the drum is mounted on the jack. The nails on the lagging should be carefully removed.
- 3.13.6 While rolling a cable drum for laying, the drum shall be supported on an axle running through its centre, the height of the axle being such that the end frames are free to rotate and do not touch the ground at any point. The cable shall be carefully uncoiled by gently pulling the cable assisted as necessary by carefully turning the drums. The quick pulling of the cable or turning the drums shall be avoided at all costs. Each cable drum shall be braked while laying is in progress to prevent sharp bending or buckling, particularly when the cable coils are sticking together.
- 3.13.7 The method of mounting the brakes is shown in Drawing No. RE/42/164 as given at P-171.
- 3.13.8 When drums are turned for change of direction, wooden blocks shall be carefully put under the drum bolts which stand out from the drum discs.
- 3.13.9 It is customary for the mate to stand in a commanding position where he can view the entire route, and shout evenly timed calls to his men to pull. If there is proper synchronization between the mate's calls and the pulling by the men, the cable will leave the drum without difficulty. It is important that the cable should be pulled with steady and even pulls and not be unnecessarily jerked or strained. On no account should a cable be allowed to twist or kink as this is likely to spring the

Armour and fracture the outer serving of the cable. When pulling cable around bends, one or two men should be stationed to give the cable the correct bend when it passes.

3.13.10 While laying the cable, employ adequate number of men such that the cable can be conveniently carried by them in both hands without stretched arms. The distance between any two persons carrying the cable shall be from 2 to 10 metres depending upon weight of cable such that the maximum sag of the cable between any two persons is not more than 0.5 metres.

3.13.11 The cable shall be gently drawn by pulling the cable, which may be assisted as required, by smoothly and slowly turning the winch. The cable shall not be twisted on any account.

3.13.12 Before laying is commenced, the cable shall be uncoiled first in a straight line supported by men and then carried to the trench and laid gently & carefully ensuring that cable is not stretched while putting in the trench.

3.13.13 While laying work is in progress one man must continuously observe the cable along its length in order to determine whether any indentations, holes or other damaged parts are apparent. Such damaged parts have to be protected immediately by the cable jointer provided with the Laying party.

3.13.14 When two or three turns of cable are left on the drum, the pulling should be stopped and the inner end of the cable removed from the slot in the drum. Pulling should then be continued. If this is not done the cable end is likely to be stretched and damaged.

3.13.15 The ends of the optical fibre cable should have an overlap of 10 M at the end of each drum for jointing purpose.

3.13.16 The conditions of the cable shall be visually inspected through out its length and in case any damage or defect is noticed, the trench shall not be filled up until the Engineer's representative is notified to examine and authorise filling of the trench.

3.13.17 MINIMUM BENDING RADIUS:

Cables should always be bent (or straightened) slowly, they should never be bent to small radius while handling. The minimum safe bending radius for optical fibre cables should be 30 times the diameter of the cable but wherever possible larger radius should be used.

3.13.18 Wherever cable has to be coiled/looped, the diameter of the coil/loop shall be greater than 30 times the diameter of the cable.

3.13.19 The RCC Joint Pit / Pull Chamber to be constructed should be as per the specification given in the Annexure 2.14.

3.14 CABLE RESERVE:

At the following locations, it will be necessary to provide reserve cable for future possible use.

- 1) Where a change to cable line is expected, the reserve to be allowed depends on circumstances.

- 2) In freshly banked soil to allow for slipping of the bank an allowance of 30 cm. should be provided for every 10 meters of trench (3 percent). The cable should be laid in a sinuous form.
- 3) Near roadways, buildings and culverts, reserve of 5 meters should be allowed at drum end.
- 4) On each side of major girder bridge a reserve of 10 meters should be left. For minor bridges 5 meters shall be left.
- 5) Where re-modeling works on culverts, bridges and track doubling work are going on, it may be necessary to keep loops of cable as an **extra reserve** pending finalization of its future route.
- 6) At the cable hut a loop of 10 meters in the cable pit.
- 7) At every Joint Pit a loop of 10 meters on either side of joint..
- 8) At every RCC Pull Chamber a loop of 15 meters

3.15 CABLE MARKERS

The RCC/Stone cable route markers shall normally be provided at a distance of every 100 meters on the straight portion of the cable route and also at diversions of the route of the cable culverts & LC gates. The joint indicators/markers shall be provided at all types of cable joints. The cable Markers provided shall be of standard RCC/stone type with letters “**RCIL O F C**” engraved and suitably painted with standard paint as per drawing attached. Cable Markers shall also be provided at each Joint Pit / Pull Chamber with/ without a joint respectively.

3.16 TOOLS REQUIRED FOR TRENCHING, CABLE LAYING AND FILLING.

TOOL'S NAME

Cable Jack
Cable Grip
Reopening Device
Free Hood Hook
Shackle free head hook
Grouling Hook
Pulling Bolt
Tension meter
Pulley
Anti Twist Device (swivel)
Roller
Flexible Cable
Pulling Rope
Brush
Mandrel
Chain
Measuring cord for strain gauge
Slip Winch
Wire rope
Portable VHF set
Measuring tape
Phowrah

Iron plate
Loader Backhoe for Drilling
Warning Tape
Caterpillar tractor
Fork Lifter
Vehicle Van type
Tacho- meter
Road measurer.

3.17 Execution of HDD (Trench less Horizontal Direct. Drilling - Boring)

- 3.17.1 Under road/platforms/railway tracks/difficult terrain etc., trench less horizontal directional drilling (HDD) method shall be adopted under the supervision of competent staff for laying of HDPE pipe (40/33 mm dia) at a depth of 1.5 meters and more (depth as per instructions of the site engineer).
- 3.17.2 The depth of trench at any of the ends should not be less than 1.5 meter in any case. Both ends of HDPE pipes should be closed properly using accessories and the pits should be properly back filled.
- 3.17.3 There should be no damage to the road/platform/tracks or any such structures etc. enroot during or after the HDD operations.
- 3.17.4 The work includes supply of all accessories required for laying of HDPE pipes.
- 3.17.5 The contractor should normally adopt HDD by machine. In difficult areas like track crossing, road crossing, sharp bends etc. the contractor may adopt manual pushing method only in short lengths with the permission of the site engineer of RailTel.

3.18 Blowing /Drawing of Optical Fibre Cable:

- 3.18.1 **OFC** should normally be **blown** through the HDPE ducts by standard blowing machines Only in exceptional cases drawing may be adopted in short lengths with the permission of the site engineer of RailTel.

NOTE: The brick protection including supply of second class bricks of standard size at site shall not be required where OFC is being provided in HDPE/DWC ducts and quad cables are not laid. However, if quad cables are also laid along with the OFC in HDPE/DWC ducts, the brick protection shall be required as per clause 3.3.5 for protection of quad cables.

For protection of OFC and or quad cables at crossing across railway tracks, road crossings, over steel girder bridges and over culverts & arch bridges or any other special cases as decided by the site engineer during execution, DWC duct 50/39 mm dia (including supply of duct and other accessories required for protection of OFC/ quad cables) may be used in place of RCC pipes as mentioned in clause no. 3.4, 3.5, 3.6 & 3.7, as per instructions of RailTel's engineers at site.

RAILTEL

SECTION - II

CHAPTER - 4

JOINTING AND TERMINATION OF FIBRE OPTIC CABLE

4.1 TECHNIQUE FOR JOINTING OF OPTICAL FIBRE CABLE

Fusion splicing shall be used for splicing fibres. This is accomplished by applying localized heating (i.e. by electric arc or flame) at the interface between two butted, pre-aligned fibre ends, causing them to soften and fuse together.

4.2 STRAIGHT JOINT FOR FIBRE OPTIC CABLE

- 4.2.1 There are various types of joint enclosures available in the market. The procedure for assembly of joint closure is described in the installation manual supplied with straight joint closure. This includes the following:

Material inside joint closure kit

Installation tools required

Detailed procedure for cable jointing

Procedure for re-opening the closure.

- 4.2.2 The Optic Fibre straight through joint closure shall be as per specn. TEC TO 910 G92 (latest) or a proven design approved by RCIL .The joint shall be protected in RCC Joint Pit as per drawing given in Annexure 2.14. (.The Optic Fibre straight through joint closure shall be of TVSE, R&M, Raychem, 3M make and shall be approved in advance by RailTel. The joint shall be protected in concrete chamber as approved by engineer- in-charge.)

- 4.2.3 Generally, the following steps are involved for jointing of the cable:

- Preparation of cable for jointing
- Stripping/cutting the cable
- Preparation of Cable and joint closure for splicing
- Stripping and Cleaving of Fibres
- Fibre splicing
- Organising fibres and Finishing joints
- Sealing of joint closure and
- Placing joint in the Jointing Chamber/Pit.

4.3 PREPARATION OF CABLE FOR JOINTING

During the installation, a minimum of 10 meter of cable of each end is coiled in the jointing pit to provide for jointing to be carried out at convenient location as well as spare length to be available for future use in case of failures.

The pit size must be chosen carefully to ensure that length of the wall on which joint is mounted is greater than closure length plus twice the minimum bending radius of the cable. A RCC circular

Joint Pit / Pull Chamber of 1 meter outer dia as given in annexure-2.14 is sufficient for most of the cable and joint closures.

The cable is then coiled and carefully placed in the pit/chamber in the same position as required after the joint is complete. The marking is done on all the loops so that it will be easier to install it later.

The distance from the last centre to the end of the cable must be at least 1.8 meter. This is being the minimum to be stripped for preparation of joint.

Sufficient cable at each end up to the jointing vehicle/enclosure is then uncoiled from the pit for jointing.

4.4 STRIPPING/CUTTING OF THE CABLE

The cables are stripped of their outer and inner sheath with each sheath staggered approximately 10mm from the one above it.

Proper care must be taken when removing the inner sheath to ensure the fibres are not scratched or cut with the stripping knife or tool. To prevent this, it is best to only score the inner sheath twice on opposite sides of the cable, rather than cut completely through it. The two scores marking on either side of the cable are then stripped of the inner sheath by hand quite easily.

The fibres are then removed from cable one by one and each fibre is cleaned individually using Kerosene to remove the jelly.

4.5 PREPARATION OF CABLE JOINT CLOSURE FOR SPLICING

The type of preparation work performed on the cable prior to splicing differs on the type of joint closure and fibre organiser used. However, the following steps are usually common :-

The strength member of each cable are joined to each other and/or to the central frame of the joint closure.

The joint closure is assembled around the cable.

The sealing compound or heat shrink sleeve is applied to the cables and closure, or prepared for application after splicing is complete.

The fibres are protected (usually with plastic tubing) in their run from the cable core to the fibre organiser trays (particularly if cable construction is slotted core type).

Tags which identify the fibre nos. are attached at suitable location on the fibres.

Splice protectors are slipped over each fibre in readiness for placing over the bare fibre after splicing.

4.6 STRIPPING AND CLEAVING OF FIBRE

Prior to splicing each fibre must have approximately 50mm of its primary protective U.V. cured coating removed, using fibre stripper which are manufactured to fine tolerances and only score the coating without contacting the glass fibre.

The bare fibre is then wiped with a lint free tissue doused with ethyl alcohol. Cleaving of the fibre is then performed to obtain as close as possible to a perfect 90 degree face on the fibre.

4.7 SPLICING OF THE FIBRES

The fusion splicing shall be used for fibre splicing. Some of the basic steps for fusion splicing are as given in 4.8 below.

4.8 FUSION SPLICING OF FIBRE

Some of the general steps with full automatic micro processor control splicing machine are as under

Wash hands thoroughly prior to commencing this procedure.

Dip the clean bare fibre in the beaker of ethyl alcohol of the ultrasonic cleaver. Switch on ultrasonic cleaver for 5-10 seconds (Some of the manufacturers do not prescribe the above cleaning).

Place the bare fibre inside 'V' groove of the splicing machine by opening clamp handle such that the end of fibre is app. 1 mm. over the end of the "V" groove towards the electrodes.

Repeat the same procedure for other fibre, however, first insert heat shrink splice protector.

Press the start button on the splice controller.

The machine will pre fuse, set align both in 'X' and 'Y' direction and than finally fuse the fibre.

Inspect the splice on monitor if provided on the fusion splicing machine and assure no nicking, bulging is there and cores appear to be adequately aligned. If the splice does not visually look good repeat the above procedure.

Slide the heat shrink protector over the splice and place in tube heater. Heat is complete when soft inner layer is seen to be 'oozing' out of the ends of the outer layer of the protector.

Repeat for other fibres.

4.9 FUSION SPLICER AND OTDR

The fusion splicer and Optical Time Domain Reflecto meter (OTDR), to be used for splicing and measurements of parameters respectively, shall be of approved design and quality. The contractor shall submit

Specification of fusion splicer and OTDR

Certificate from the users, who have used the splicer and OTDR of the make, the contractor intends to use, regarding their satisfactory performance.

The RCIL reserves the right to direct the contractor to use the same or any other proven design of fusion splicer and OTDR if in the opinion of RCIL the specification of Fusion splicer and OTDR are not suitable

4.10 ORGANISING FIBRE AND FINISHING JOINTS

After each fibre is spliced, the heat shrink protection sleeve must be slipped over the bare fibre before any handling of fibre takes place, as uncoated fibres are very brittle and cannot withstand small radius bends without breaking.

The fibre is then organized into its tray by coiling the fibres on each side of the protection sleeve using the full tray side to ensure the maximum radius possible for fibre coils.

The tray are placed in the position.

OTDR reading taken for all splices in this organized state and recorded on the test sheet to confirm that all fibres attenuation are within specification. This OTDR test confirms fibres were not subjected to excessive stress during the organizing process.

After this the joint can be closed with necessary sealing etc. and ready for placement in the pit.

- 4.10.1 Jointing Pit/ Pull Chamber::** The Jointing Pit / Pull Chamber is as per drawing at Annexure-2.14. The outer dia of the circular RCC Jointing Pit / Pull Chamber shall be approx. 1000mm. The pits shall be located at every 1Km of the OFC route and spare cable of 15 meters to be looped and placed in the pit. The pit shall be refilled with dry sand after completion of the work and then closed. Stone/RCC route markers shall be provided for identification of each Jointing Pit / Pull Chamber location with/without a joint and this should be incorporated in the as-built-cable route plan.

4.11 PLACING OF COMPLETED JOINT IN PIT

Joint is to be placed on the tarpaulin provided near the pit.

The cable is laid on the ground, loop the cable such that pen mark previously place on the cable line up. Tape these loops together at the top of the coil.

The joint can now be permanently closed and sealed by heating heat shrinkable sleeve etc. However, before closing, silica gel to be kept inside for moisture protection.

Now the joint closure is placed in the jointing pit /chamber and the pit is closed after filling it with dry sand.

4.12 RE-OPENING OF THE JOINT

If required for attending to faults etc., manufacturers supply special kits for opening of the joint and the steps to be followed. However, the general steps are as under: -

Using suitable knife cut heat shrink sleeve longitudinally along its entire length.

Do not damage the smaller heat shrunk sleeve on the ends of the joint.

Apply heat to the cut sleeve until it begins to separate.

Gently remove the cut sleeve from the joint. Now the joint can be opened.

Protective sleeve/cover can be removed for attending to faults etc.

4.13 TERMINATION JOINT FOR FIBRE OPTIC CABLE.

4.13.1 This joint is provided in the cable hut for terminating the outdoor fibre optic cable of both the sides, splicing through fibres, connecting fibres to pigtails for connection to Optical Line Terminal Equipment etc.

4.13.2 The OFC Cables shall be dressed up on teak wood plank/Aluminum ladder inside cable hut. The armour of the OFC Cable shall be cut before taking the cable in the equipment rack. The cables shall be terminated on FDMS and derive required pigtails.

Two pairs of fibres shall be derived from either side cable at every OFC cable hut through pigtails with FC/PC connectors. The remaining fibres shall be looped through.

4.13.2 The procedure for installation of termination joint box depend upon the type of joint enclosure. The installation manual supplied gives the step-by-step procedure for installation. However, the general steps are as under:-

- Marking the cable
- Stripping/cutting the cable
- Gripping cable in sheath/clamp
- Treatment of tension member
- Fibre splicing
- Enclosing fibre
- Fixing strength member
- Closing the cover
- Fixing termination box
- Fixing the cable.

4.14 MARKING THE CABLE

Determine the cable length up to the proposed location of termination box. It is also to be ensured that at least 10 meters of cable is coiled in the cable pit.

Determine the cutting point and mark the cable

Determine the sheath peeling point and mark the cable

4.15 CUTTING / STRIPPING THE CABLE

Cut the cable as per the marking

Remove the sheath from cable ends. During sheath stripping care should be taken not to damage the fibres.

The length and the steps for various sheath cutting shall be as per the instruction given in the manual.

4.16 GRIPPING THE CABLE

Wind PVC tape around the cable core just beside edge of the sheath.

Insert the bushing inside sheath by cutting the cable sheath for about 25mm.

Place the sheath grip (lower half and upper half) and tighten it with the help of torque wrench.

4.17 FIXING OF TENSION MEMBER

- a) Mark the tension member for the specified length and cut it.
- b) Clean the tension member thoroughly by Alcohol and cotton cloth.
- c) Fix tension member holder with the help of instant adhesive at the end of tension member.

4.18 FIBRE SPLICING

The procedure for splicing is same as described for straight joint closure in Clause 4.7 above.

4.19 ENCLOSING FIBRES

- a) Set the fibre cassette on the base
- b) Arrange excess length of fibre to make double figure of eight.
- c) Enclose the spliced fibre and its excess length carefully.
- d) Repeat the procedure for other fibres.
- e) After this, the box can be closed. However, a packet of silica gel may be placed inside for protection from entry of moisture.

4.20 MOUNTING OF TERMINATION BOX.

Termination box can be fixed either on wall or on equipment rack. At wayside stations it shall be mounted inside the equipment rack in order to prevent pigtailed from rodent attacks.

- a) Mark the fixing holes on the walls/bracket/frame
- b) Place the termination box and tightened the nuts inside the base box.
- c) Put the covers.

4.21 FIXING THE CABLE

Secure the cable on wall/frame at two places within one meter from termination box keeping in view straight entry of cable in termination box.

4.22 ISOLATION OF ARMOUR OF OFC CABLE

The maximum continuous length of armour of OFC Cable should not exceed 1.6 Kms. in order to keep the induced voltage within permissible limits. Where the continuous length of cable exceeds 1.6 Kms. a 50 mm cut shall be made in the armour after every 1.6 Kms. The Exposed cable at the cut shall be covered by shrinking suitable heat shrink sleeve as per TEC specifications.

4.23 ACCEPTANCE TEST FOR FIBRE OPTIC CABLE

The Procedure for Testing of Fibre Optic Cable shall be jointly finalized by Contractor with Engineer of the RCIL. The parameters in the concerned specification shall be taken as reference. The Test shall be conducted from cable hut to cable hut, after the Splicing & termination Joints are completed. The length of cable (as per marking in cable & as measured by OTDR), loss in cable, average loss per Km., No. of Splices, Splice loss, etc. shall be recorded and jointly signed as per pro-forma given in para 4.24 below.

4.24 TEST PROTOCOL FOR OPTICAL FIBRE CABLE

SYSTEM TEST PROTOCOL OPTICAL FIBRE CABLE FIELD TEST

Route: ----- Date: -----
 Station: ----- No. of mid-section splices: -----
 Section: ----- Measured by: -----
 Length (by OTDR): ----- Length as per meter marking on cable sheath-----

- 1)
- 2) Optical measurements (On Line):

Measurement	Fibre – number	Accepted Value
	1 2 3 422 23 24	
1.1 Total attenuation at 1300/1550 nm with OTDR		
1.2 Total attenuation per Km at 1300/1550 nm:		<0.40 dB/Km at 1300 nm &<0.25 at 1550 nm
1.3 Splice Loss in dB with OTDR Location		Average splice loss
OHE Mast No./ Overhead alignment post no. A. B. C. D. E.		
Average Splice Loss		0.15 db, no splice should have loss >0.2 db

NOTE : ALSO ATTACH OTDR RESULTS |----|

2) Visual Inspection (On Line):

2.1 No. of Cable drum used in the section: -----

2.2 S.No. of cable and length of each drum:

<u>S.No.</u>	<u>LENGTH</u>
1. -----	-----M
2. -----	-----M
3. -----	-----M
4. -----	-----M
5. -----	-----M

2.3 Location of Isolation Sleeves: 1. 2. 3.

Contractor's Representative

RCIL's Representative

25 TOOLS AND EQUIPMENTS REQUIRED FOR JOINTING AND TERMINATION OF FIBRE OPTIC CABLE.

- | S.No. | TOOL's Name |
|--------------|--|
| 1. | Branch Joint Closure |
| 2. | Termination Box |
| 3. | Rubber end Block |
| 4. | Sheath Clamp |
| 5. | Bushing |
| 6. | Strength Member holder |
| 7. | Heat Shrinkage tube |
| 8. | Arc fusion splicer machine. |
| 9. | Power cord AC/DC |
| 10. | Walkie-Talkie 12V DC source |
| 11. | Tube heater |
| 12. | Precision cleaver |
| 13. | Cable sheath stripper |
| 14. | Fibre stripper |
| 15. | Knife for HDPE cutting |
| 16. | Hexa for strength membrane |
| 17. | Isopropyl alcohol or methanol of high specific gravity |
| 18. | Johnson Buds |
| 19. | Tweezers |
| 20. | Gun heater Blower type |
| 21. | Sleeve for splice protection |
| 22. | O.T.D.R. |
| 23. | Stickers for numbering of splicers. |
| 24. | Portable k. oil generator |
| 25. | Umbrella's 2 Nos. |
| 26. | Dust protection for splicing machine |

Note:- Wherever cable has to be coiled/looped , the diameter of the coil/loop shall be greater than 30 times the diameter of the cable.

SECTION-II

CHAPTER-5

Technical Specification and Drawing for provision of Earthing Arrangement.

1. Introduction The Earthing arrangement is required to provide earth for Telecom equipments. The earth resistance should be less than **1 (One) Ohm** as per following Drawing: g)

Maintenance Free Earthing

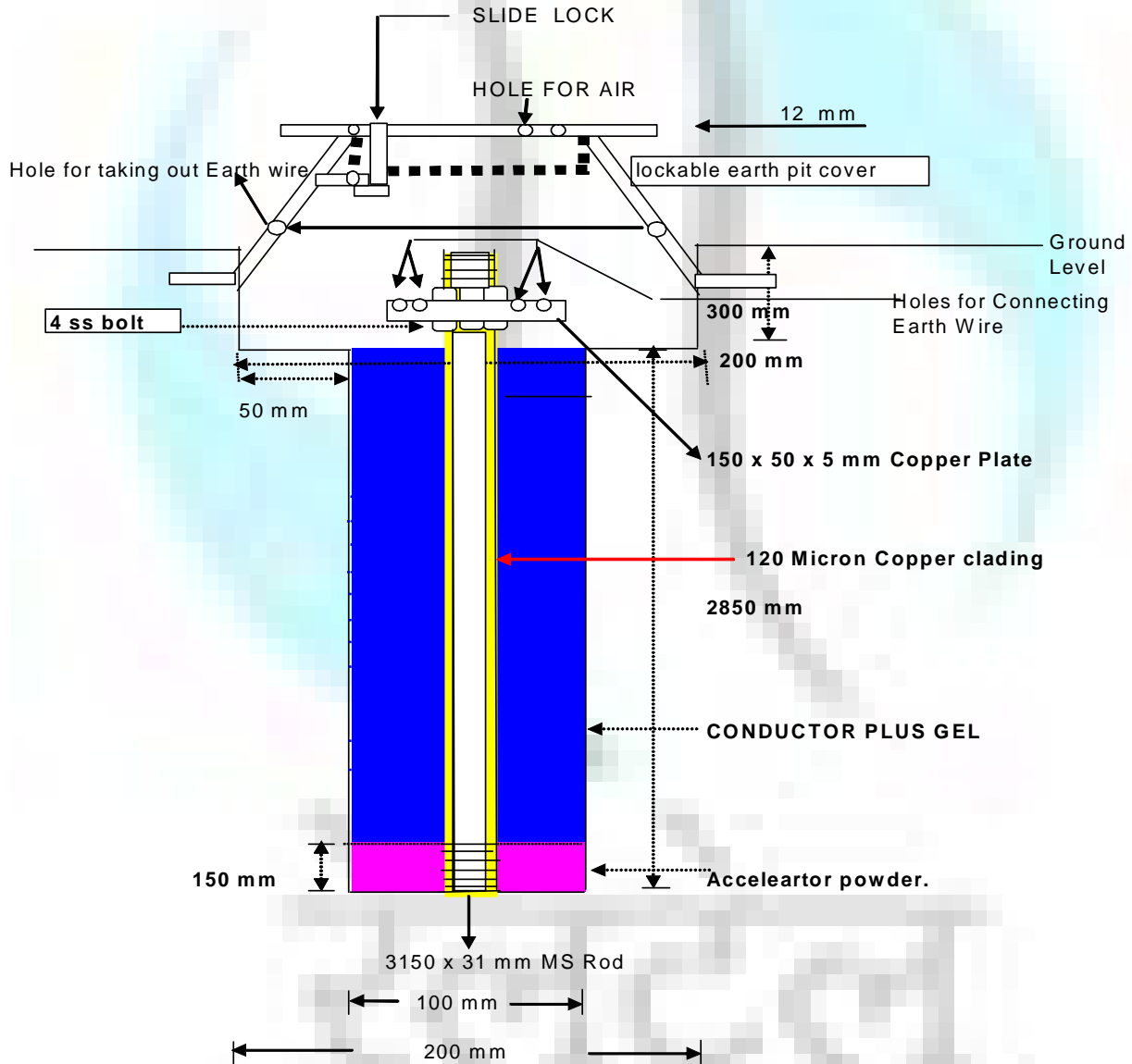

RAILTEL

SECTION-II

CHAPTER-6

Jointing of 6 Quad Telecom, Cable and Acceptance Test (Not applicable for present tender)

Scope: This chapter Deals with the requirements of various types of joints on 6 Quad cable, jointing procedure, V.F.Transformers and the acceptance test etc.

6.1 A tentative quad allocation of a 6 Quad cable , When laid along with OFC is as under

Quad No1 -	Block
Quad No2 -	Spare
Quad No3 -	Emergency Communication
Quad No4 -	½ Quad-gate Telephone ½ Quad-for Block Proving by Axle Counter (BPAC)
Quad No5 -	Block providing by Axle counter(BPAC)
Quad No6 -	Train Actuated Warning System(TAWS)

6.2 Thermo shrink jointing kits as per specification no.IRS-TC-77-2000 with latest amendments shall be used for various types of joints in:

- i. 6 Quad jelly filled cable of specification No.IRS-TC-30-05 with latest amendments having 0.9 mm diameter.
- ii. PIJF underground telecom cable of different pair size 10/20 pairs with copper conductor having diameter 0.63mm.

The 2T/3T (1 Quad) VF transformer as per specification No. IRS-TC-76/2000 with latest amendments for thermo joints etc. shall be used for thermo shrink transformer joints.

6.3 With optical Fiber application, the 6 Quad cable is meant for carrying circuits only between two stations. As the joint is always a weak link, efforts shall be made to club two or more joints in one if falling within 100 mtrs.

6.3.1 The straight through joints shall be provided for normal jointing of cable.

6.3.2 For L.C Gate pump houses etc. the straights through joints with branching clip shall be provided for deriving the circuit using 10 pairs PIJF cable. No isolation transformer is considered necessary upto the distance of 7.5 km.

6.3.3 Transformer joints shall be used for deriving emergency socket approx at 1 km distance. This joint shall generally be combined along with normal joint. The tapping shall be derived through V.F transformer 470:1120 using PIJF cable as the phantom circuit is not required, the center tap wires of transformers shall be cut permanently and not derived.

6.4.1 L.C gate quad shall be terminated directly without V.F transformer to permit passing of magneto ring.

6.4.2 2T/3T V.F transformers shall be connected in the transformer bay for both side emergency control circuits.

6.4.3 A krone termination box as per TEC specification shall be mounted to facilitate termination of cables for the derivation purposes.

6.5 LONG BLOCK SECTIONS & SIDING:

6.5.1 In case of long block sections and siding (>15 kms) it may be necessary to carry out loading and balancing of 6 quad cable to reduce the loss & cross talk.

6.6 JOINTING PROCEDURE:

- 6.6.1 For jointing of cable, pit as per Drg. No.CORE/S&T/ALD/SK/438/95 (Annexure 4.2) is made. The pit surface is leveled by ramming the earth. In case of loose soil or mud, bricks or ballast may be used, if necessary. A tent may be placed over the pit to protect against adverse weather/Dust.
- 6.6.2 Bend the two cable ends slowly into an "S" shape taking care that the cables are not strained excessively and minimum overlap of 350 mm is available.
- 6.6.3 Prepare the cable ends as per the detailed installation instructions supplied by jointing kit manufacturer for making heat shrinkable joints for 6 quad cable fastly.
- 6.6.4 Preliminary checks may be carried out using multimeter for continuity of conductors & breaks/crosses etc. if any. The insulation is measured between all conductors bunched together and screen/armour by V megger. The equivalent average insulation resistance/conductor/Km/ is obtained by multiplying the megger reading with the number of conductors and the length of cables in Kms.
- 6.6.5 Slip the quad rings on a P.E insulated quad of the cable end. Similarly slip another quad ring on the corresponding PE insulated quad of other cable ends. Select a conductor, slip a PE sleeve over it. Take the corresponding conductor of the corresponding PE quad of the other cable end. Peel off the P.E insulation from these conductors for a length of 50mm.
- 6.6.6 Bring the two conductor together perpendicular to the cable. Twist the two conductors by rotating giving approximately 10 turns for length of 25mm. Cut off the surplus wire. Solder half the length of twisted conductors using solder resin coe, solder bit flat & blow lamp. Fold the twisted conductors along the main cable conductors and allow it to cool. Draw the PE sleeve over the twisted joints in such a way that former projects equally on the two sides of the latter and equally covers the polyethylene insulation of the two conductors. It should be ensured that the PVC sleeve fits properly over the twisted joint is not able to move easily over it.
- 6.6.7 For tapping joint, select the quad from which the circuit is to be tapped. Cut the quad. Slip numbered group ring over both ends as also on the lead wire bunch of required transformer. Select a conductor in one quad and slip a P.E sleeve over it and its other end. Select a conductor, a short lead wire and transformer lead wire and make twisted joint. With the other end of the short lead and other cut end of same conductor, make another twisted joint.
- 6.6.8 The conductors of remaining PF Quads should also be joined accordingly.
- 6.6.9 Complete the joint as per the detailed installation instructions supplied by the jointing kit manufacturer for making heat shrinkable joints for 6 quad cable.

6.7 JOINTING & TERMINATION OF PIJF DERIVATION CABLES.

- 6.7.1 Thermo shrink joints of appropriate size for straight through or branch off joints as per specification shall be provided.
- 6.7.2 All the PIJF cables shall be terminated on krone or CT box of suitable size duly mounted on the wall in subscriber premises.

6.8 CAPICITANCE UNBALANCE:

- 6.8.1 In the electrified sections, the capacitance unbalances between cable conductors and cable sheath /armour (earth) introduces appreciable noise in the circuits. This can be reduced by polling i.e. connecting cable pairs straight or across at normal joints.
- 6.8.2 In any manufactured length of a cable, the capacitances between conductors of a quad and between conductors of adjacent quads and those between conductors of a pair and the cable sheath (earth) are not perfectly balanced which gives rise to the capacity interference between various circuits and the circuits and earth. Balancing of these capacitances is hence necessary to limit the cross-talk and to bring the cross-talk attenuation within permissible values.

This is done by adding extra capacitances between pairs. The permissible limits of capacitance unbalances in balanced cabling are 40 pf for full loading section.

6.9 ACCEPTANCE TESTS FOR 6 QUAD AND PIJF CABLES:

The characteristic impedance of unloaded 6 quad Telecom. Cable (IRS TC-30/2005 with last Amendment) is 470 ohm +/- 10% at 800Hz. When loaded with inductance of 88mH, the characteristic impedance is 1120 ohm +/- 10%.

Joint tests are to be carried out by Engineer's representative and contractor's representative for accepting the cable from the contractor.

- 6.9.1 Testing of V.F. Transformers: Following tests may be conducted on V.F. Transformers before using in the joint.
 - a) **Continuity and DC resistance of windings:** Use an AVO meter to check continuity. Measure DC resistance of primary /secondary windings with a LAR bridge. The readings obtained should be comparable.
 - b) **Insulation Resistance:** Connect one lead of a 500 V megger to one winding connect the other lead of Megger First to another winding and take reading. Next connect it to all other windings connected together and the case and again take the reading. Insulation resistance should not be less than 10,000 Mega ohms.
 - c) **Insertion Loss:** Adjust output level of transmission measuring set to 0 dB and connect it across the primary of transformer. Connect a dB meter on the secondary side. DbB meter reading should not be more than 1 dB.

6.9.2 LOOP RESISTANCE AND CONTINUITY TEST:

Instrument to be used: Multimeter

- a) The multimeter will provide ready means for continuity test and also it will be capable of testing D.C. and A.C. Voltages, D.C. resistance and also low frequency levels for test and maintenance purpose. The input sensitivity shall be atleast 100 k ohm per volt of A.C.
- b) The maximum average loop resistance of a pair measured with direct current at 20 deg. C. Shall be 56 ohm per km. For the PF quads of 0.9 mm diameter copper conductors. The nominal loop resistance of a pair shall be 55.2 ohms per km. At 20 deg. C. This test shall be carried out only on untapped pairs of cable.

6.9.3 INSULATION TEST:

Instrument to be used –Mega ohm Meter /Megger

- a) The insulation resistance measured between a conductor of a quad and all conductors of all other quads connected together to the sheath and earth shall not be less than 625 megaohms per kilometer when measured at 500 volts D.C after energizing for one minute at a temperature of not less than 16 deg.C. The remaining three conductors of the quad under test may be left floating.

The insulation at 16 deg. C may be found out by the formula –

$$\text{Insulation at 16 Deg. C} = \text{Insulation at T Deg. C} \times 1.04^{(T - 16) \times 9/5}$$

- b) For measuring insulation all conductors may be bunched together and tied properly with a bare wire and insulation to the sheath/screen measured. The insulation resistance per km can be obtained as –No. Of wires tested x Deflection (Megs) X Length (km) = Megaohms per km....

6.9.4 FREQUENCY ATTENUATION & TRANSMISSION MEASUREMENTS:

Instrument to be used – Transmission Measuring Sets (IRS TC 43-87)

Two Transmission measurements sets are required for this measurement. One set is kept at one end of the cable and at the other end of the cable. Before sending the set to other end the zero errors of all meters are checked. Zero dB tone is sent from one end and the level received at the other end and is measured. Wherever the frequency is changed the zero level should be adjusted again. Zero level of the tone should also be adjusted first before taking any reading.

The reading are taken at the following frequencies 300Hz, 400Hz, 600Hz, 800Hz, 1000 Hz, 1400Hz, 1600Hz, 2000 Hz, 2400 Hz, 2800 Hz, 3000Hz. and recorded.

The transmission loss, return loss, insertion loss etc are measured and recorded.

6.9.5 CROSS-TALK MEASUREMENT:

Instrument to be used –

- a) **Cross-talk measuring set (IRS TC-45)**
- b) **Oscillator 1 kHz / 800 Hz Zero dB**

Tone of 800 Hz is given on one pair and cross talk is measured on the other pair in the same quad. Also the Cross-Talk has to be measured in adjacent quads, Cross-Talk is measured at 'Near-End' and also 'Far-End'. The Far-End Cross-Talk attenuation between any two air spaced paper insulated VF pairs at a frequency of 800Hz shall not be less than 65 dB. The Near-End Cross-Talk shall not be less than 61 dB.

6.9.6 PSOPHOMETRIC NOISE LEVEL MEASUREMENT:-

Instrument to be used - PSOPHOMETRIC (RDSO SPECN. No.STE/RE/C/SPN (MI)-1975(Latest))

SIEMENS Germany Model No. V 2233(1994) or APLAB India Model No. 1071/R(1995) are presently used for measurement of noise. The detail procedure for measurements is supplied by manufacturer. The Far end of test pair is terminated at the resistance equivalent to characteristic impedance of the cable (600 or 470 or 1120 ohms). At near end psophometer is connected. The readings of weighted and unweighted noise can be directly read on the meter. The permissible limit of psophometric voltage is 2 mv.

6.9.7 MEASUREMENT OF CIRCUIT ELEMENTS:

**Instrument to be used – Impedance Bridge (LCR Bridge)
{Specn.No.STT/RE/SPN(MI)-1973}**

This measures electrical data of components like coils, capacitors and transformers as well as of subassemblies, amplifiers, filters etc. The measurement of resistive and reactive components of impedance and admittance can also be measured with this bridge. These parameters are generally factory tested and need not be measured at site. The impedance bridge can also be used for assessing the distance of cable fault/low insulation quad with reference to healthy quads.

6.9.8 TOOLS & ACCESSORIES REQUIRED FOR JOINTING OF 6 QUAD /PIJF/DERIVATION CABLE & TERMINATION:

6.9.9 The following tools are required:

i)	Pick axes	3
ii)	Phowras	2
iii)	Measuring tape(10 meters)	1
iv)	Tent complete with spikes and Ropes	1
v)	Hammer to Spikes	1
vi)	Rammer	1
vii)	Jointing trestle	1
viii)	Jack knife	1
ix)	Pocket Knife	1
x)	Combination side-cutting pliers	1
xi)	Hacksaw frame& Blade	1
xii)	Long nose plier with side cutter	1
xiii)	Tringular file	1
xiv)	Wire brush	1
xv)	File flat	1
xvi)	Blow lamp petrol	1

xvii)	Blow lamp kerosene	2	
xviii)	Mirror		1
xix)	Brush		1
xx)	Wooden mallet		1
xxi)	Flat nose pliers		1
xxii)	Diagonal cutting nipper		1
xxiii)	Solder bit flat		1
xxiv)	Screw driver set		1
xxv)	Metal rule steel		1
xxvi)	Open jaw spanner set	1	
xxvii)	Wrench adjustable		1
xxviii)	Scissor ordinary		1
xxix)	Chisel		1



SECTION - II

CHAPTER - 7

List of Address for Specification

6.0 Address from where specification copy can be purchased :

The copy of IRS, RDSO, TEC and BIS specification used in the tender documents can be purchased from following sources.

- 6.1 IRS Specification :**
- i) Manager Publications,
Government of India
Civil Lines, New Delhi- 110054
 - ii) Government of India Book Depot,
8 - S.K. Roy Road, Calcutta – 700001
- 6.2 RDSO Specification :**
- RDSO, Manak Nagar, Lucknow
- 6.3 DOT/TEC/ITD Specification :**
- Khurshid Lal Bhavan, Janpath,
New Delhi- 110001
- 6.4 B.I.S. Specification :**
- Directorate General,
Indian Standards Institution,
9- Bahadur Shah Zafar Marg,
New Delhi -110002
F- block, Unity Building,
Narsimhrajra Square,
Bangalore- 560002
534- Sardar Vallabh Bhai Patel Raod , Mumbai.
5- Chowringhee Approach, PO Princep Street, Calcutta- 700072
Ahinsa Building (1st floor) , SCO 82-83, Sector 27-C, Chandigarh-
160017
5-8-56/57, L.N. Gupta Marg, Hyderabad- 208005.
117/418-B, Sarvoday Nagar, Kanpur – 208005
C.I.T. Campus, Adyar, Madras – 600020.
- 6.5** If any specifications and drawings referred but not enclosed in the tender documents may be seen in the RCIL's office on any working day.

SECTION – III**DRAWINGS**

S.No.	Description of Drawing	Page No.
1	Sketch showing procedure for excavation of Trench	139-143
2	Metalled Road Crossing in RCC/DWC pipe	144
3	Arrangement of cable laying in Rocky area.	145
4	Chase cutting in Rocky area	146
5	RCC circular jointing chamber	147
6	RCC/Stone cable route marker	148
7	Telecom Earthing	149
8	Typical Network for Wi-Fi Services at stations	150
9	Typical arrangement for Dual Homing of Access Switches	151



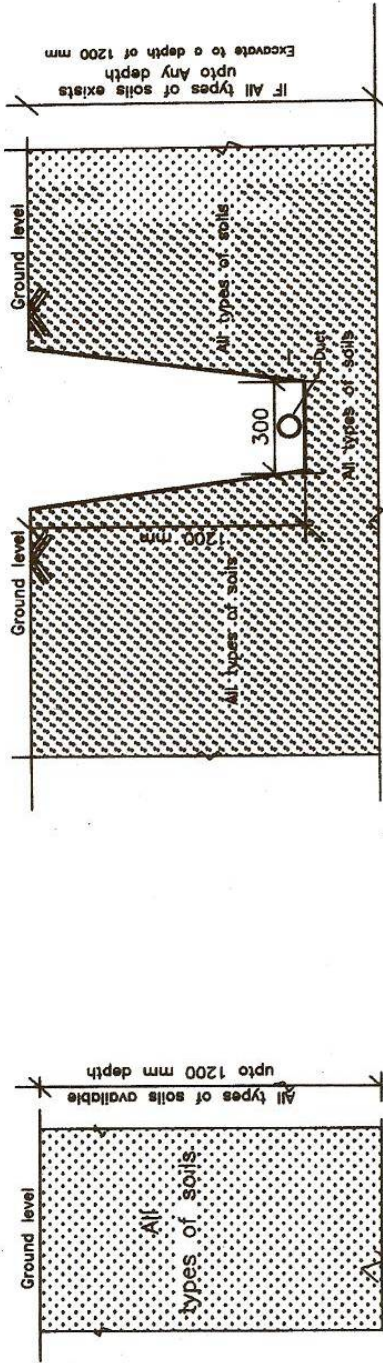

SOIL STRATA.
FIG.1.1

Note: All dimensions are in millimetres.

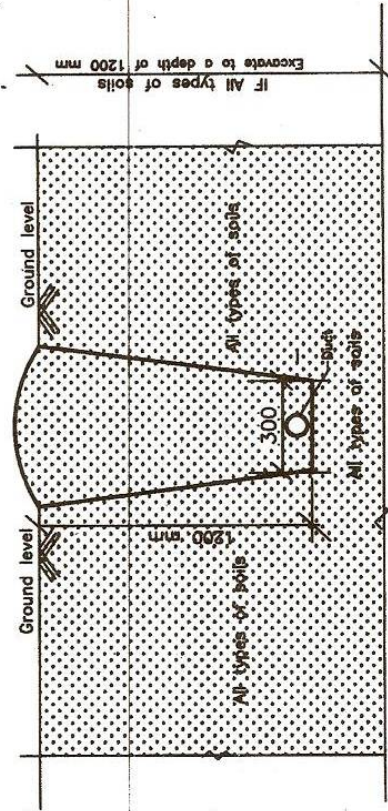

DURING EXECUTION OF WORK.
FIG.1.2

AFTER COMPLETION OF REFILLING.
FIG.1.3

RAILTEL CORPORATION OF INDIA Ltd..	
RGM/SR/SC.	DRG No.RAILTEL/SR/OFC/2008/1.
SKETCH SHOWING THE PROCEDURE FOR EXCAVATION OF CABLE TRENCH IN ALL TYPES OF SOILS (Normal soil/Soft soil/Sandy soil)	
NOT TO SCALE	
CONSULTANT.	(G VEERASWAMY) <i>lubb</i>
MANAGER/PROJ	(M MURALI KRISHNA) <i>M. murali</i>
AGM/SC.	(P V MURALI KRISHNA) <i>P. V. Murali Krishna 15/10/16</i>

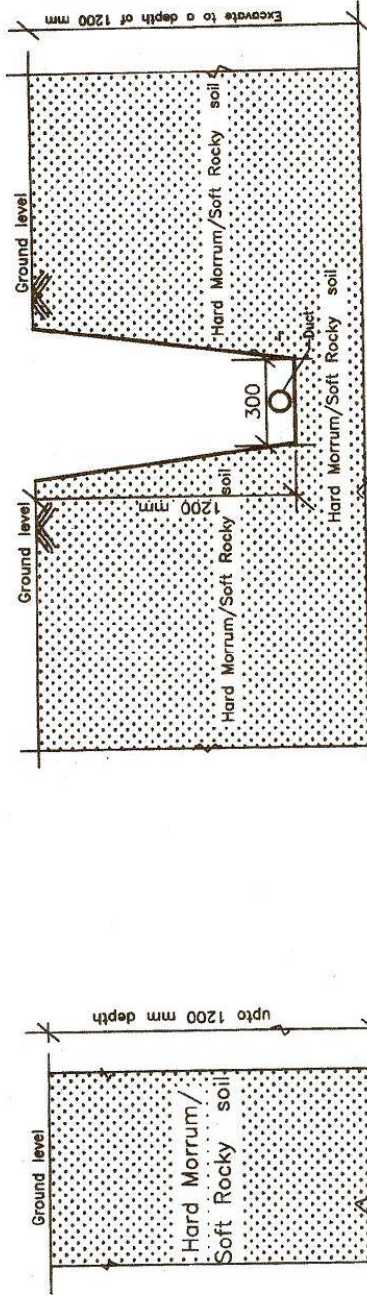

SOIL STRATA.
FIG.2.1

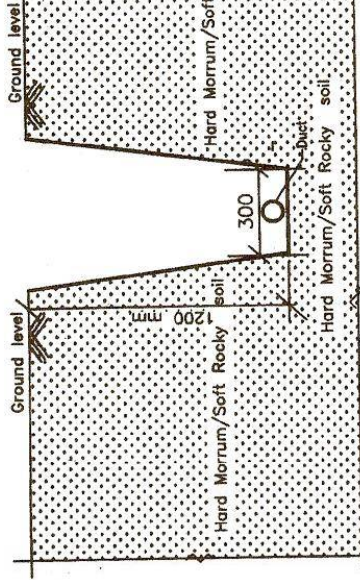

DURING EXECUTION OF WORK.
FIG.2.2

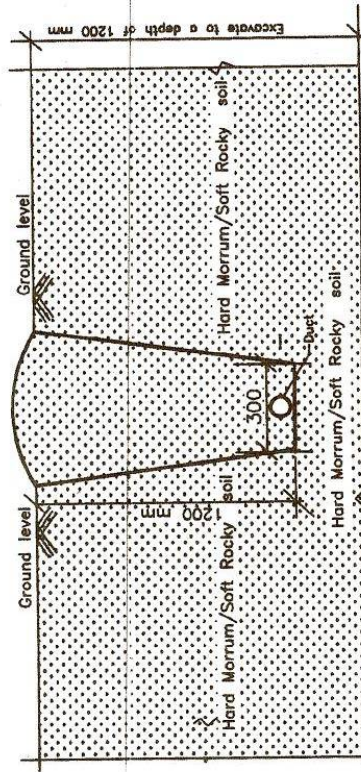

AFTER COMPLETION OF REFILLING.
FIG.2.3

Note: All dimensions are in millimetres.

RAILTEL CORPORATION OF INDIA Ltd.	
RGM/SR/SC.	DRG No.RAILTEL/SR/OFC/2008/2.
SKETCH SHOWING THE PROCEDURE FOR EXCAVATION OF CABLE TRENCH IN Hard Morrums/Soft Rocky soil	
NOT TO SCALE	
CONSULTANT.	(G VEERASWAMY)
MANAGER/PROJ	(M MURALI KRISHNA) <i>M. Murali</i>
AGM/SC.	(P V MURALI KRISHNA) <i>P.V. Murali Krishna</i> 15/2/18

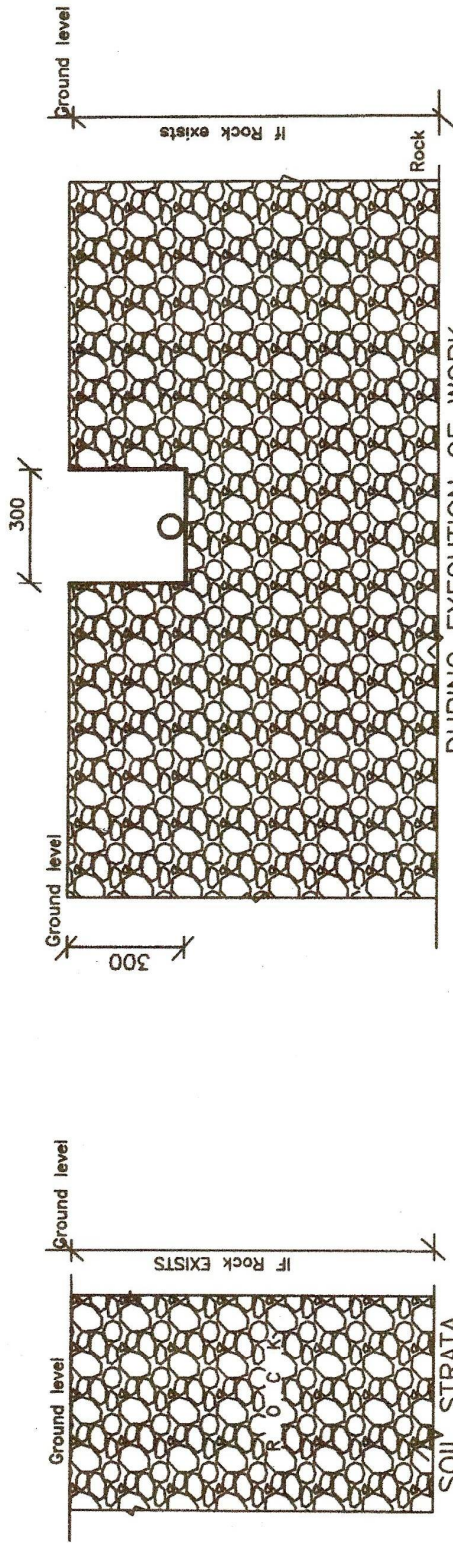

SOIL STRATA.
FIG.3.1

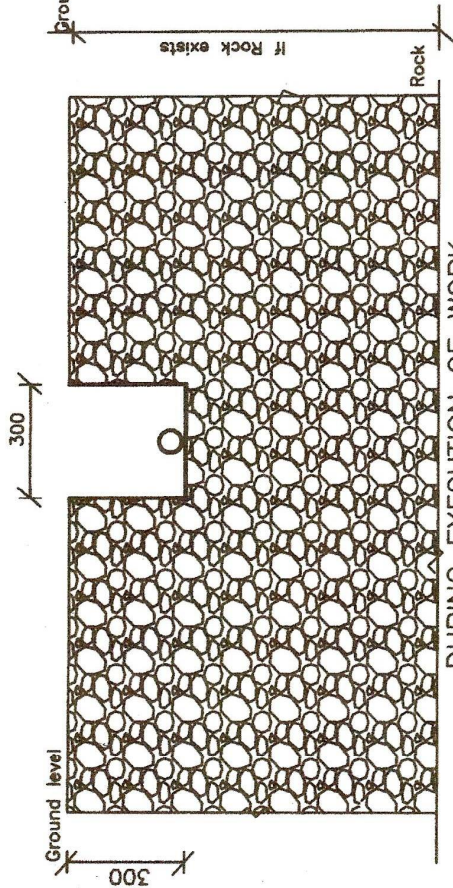

DURING EXECUTION OF WORK.
FIG.3.2

NOTE;
1.All dimensions are in millimetres.

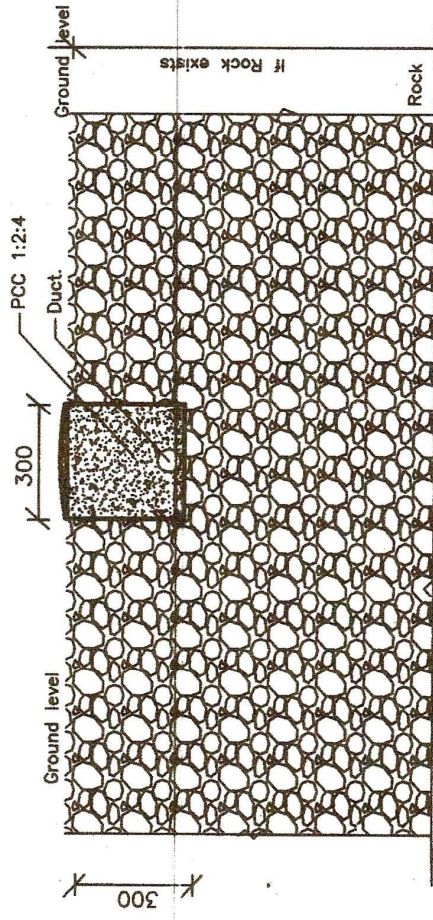

AFTER COMPLETION OF WORK.
FIG.3.3

RAILTEL CORPORATION OF INDIA Ltd..	
RGM/SR/SC.	DRG No.RAILTEL/SR/OFC/2008/3.
SKETCH SHOWING THE PROCEDURE FOR EXCAVATION OF CABLE TRENCH IF ROCK EXISTS FROM SURFACE OF GROUND.	
NOT TO SCALE	
CONSULTANT.	(G VEERASWAMY) <i>Subb</i>
MANAGER/PROJ	(M MURALI KRISHNA) <i>M. murali</i>
AGM/SC.	(P V MIRALI KRISHNA) <i>P.V. Mirali Krishna</i> 15/1/16

Depth of Rock from surface	Cutting of ROCK.		Plain cement concrete	
	width	depth	Top level	Bottom level
300	200	200	300	500
350	200	200	350	550
450	200	200	450	650
550	200	200	550	750

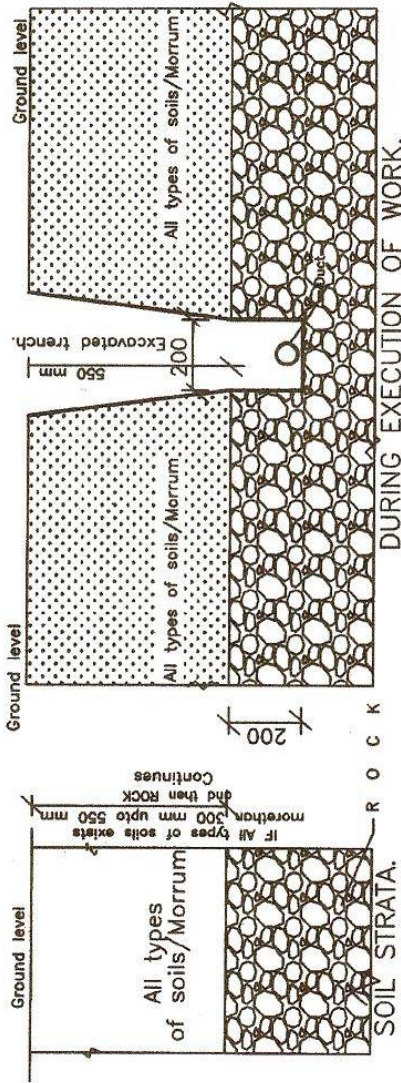
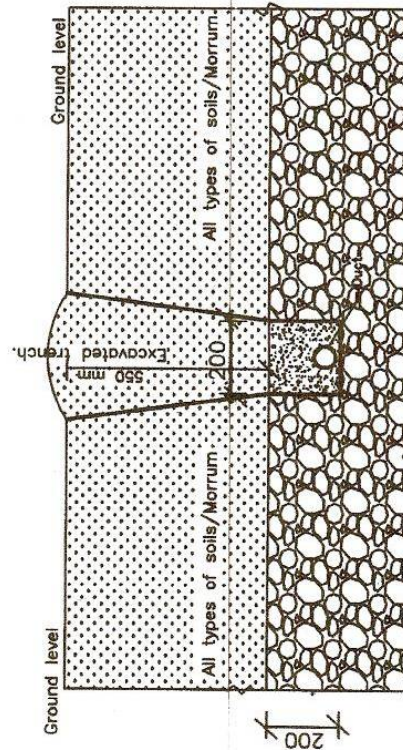

FIG.4.2 DURING EXECUTION OF WORK.

NOTE:

1.All dimensions are in millimetres.



RAILTEL CORPORATION OF INDIA Ltd.	
RGM/SR/SC.	DRG No.RAILTEL/SR/OFC/2008/4.
SKETCH SHOWING THE PROCEDURE FOR EXCAVATION OF CABLE TRENCH IF ROCK EXISTS MORE THAN 300 TO 550 mm FROM G.L.	
NOT TO SCALE	
CONSULTANT.	(G VEERASWAMY)
MANAGER/PROJ	(M MURALI KRISHNA)
AGM/SC.	(S V MADAI KRISHNA)

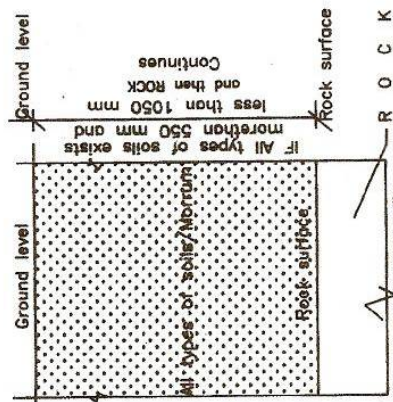

FIG.5.1

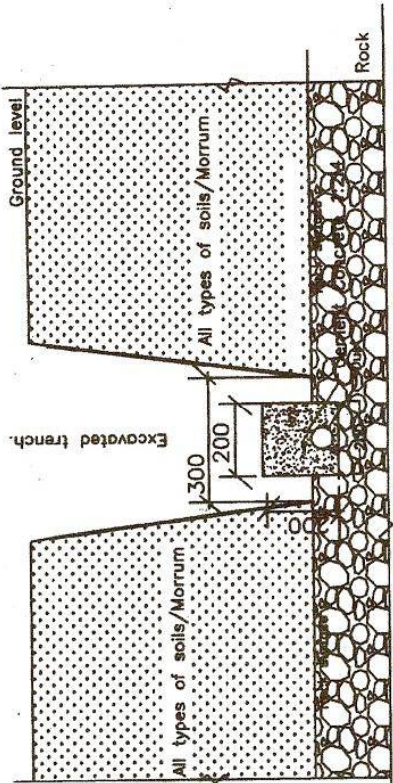

FIG.5.2

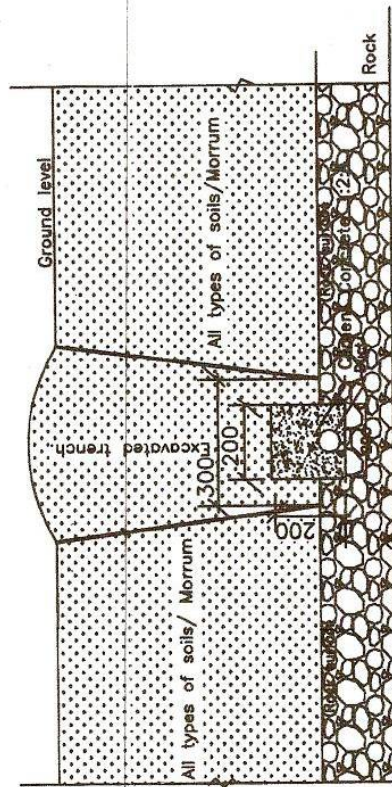

FIG.5.3

Note: All dimensions are in millimetres.

Depth of Rock from surface	Cutting of ROCK		Plain cement concrete	
	width	depth	Top level	Bottom level
800	200	150	550	750
850	200	100	550	750
750	200	NI	550	750
850	200	NI	650	850
950	200	NI	750	950
1050	200	NI	850	1050

NOTE;
1.All dimensions are in millimetres.

RAILTEL CORPORATION OF INDIA Ltd..	
RGM/SR/SC.	DRG No.RAILTEL/SR/OFC/2008/5.
SKETCH SHOWING THE PROCEDURE FOR EXCAVATION OF CABLE TRENCH IF ROCK EXISTS morethan 550 and lessthan 1050	
NOT TO SCALE	
CONSULTANT.	(G VEERASWAMY)
MANAGER/PROJ	(M MURALI KRISHNA)
AGM/SC.	(P V MURALI KRISHNA)

ANNEXURE 3.2

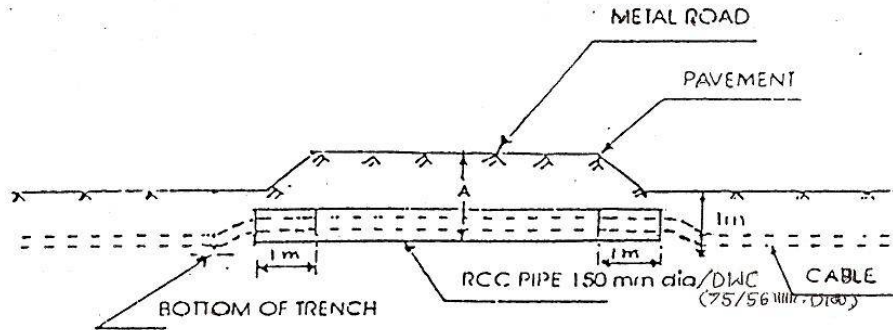

NOTE :-

1. 'A' = DEPTH WILL BE 1-METER MIN.

OR

AS DECIDED BY THE ENGINEERS
AS PER SITE CONDITION.

2. LENGTH OF R.C.C. PIPE SHALL
BE EXTENDED BY 1 m. BEYOND
ROAD EDGES.

-	CSTE	DRN.	ARRANGEMENT OF RCC PIPE TRUNKING UNDER METAL ROADS	DRG NO. RE/S31/ A10/S4/497/2000
-	DY CSTE	SE/D		PG
-	SSTE/T	SETT	RAILWAY ELECTRIFICATION	DT. 30-11-2000
-	ASTE/T		BASED ON DRG. NO. RE/S4T/ALD/ SK/163/81	NOT TO SCALE

ANNEXURE 3-11

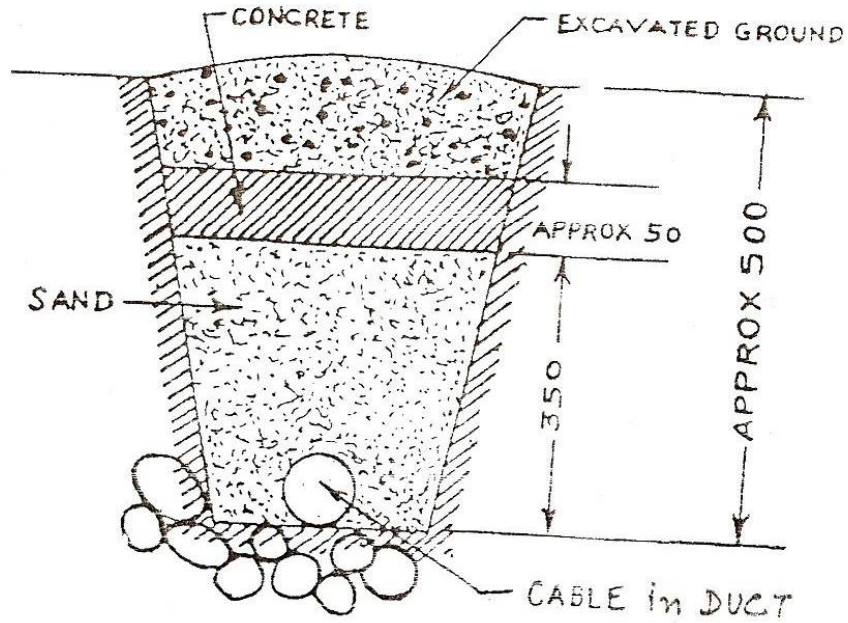

- 2. NOT TO SCALE.
- 1. ALL DIMENSIONS ARE IN mm.

NOTES

R . D . S . O .
LAYING OF FIBRE
OPTIC CABLE IN
ROCKY AREA

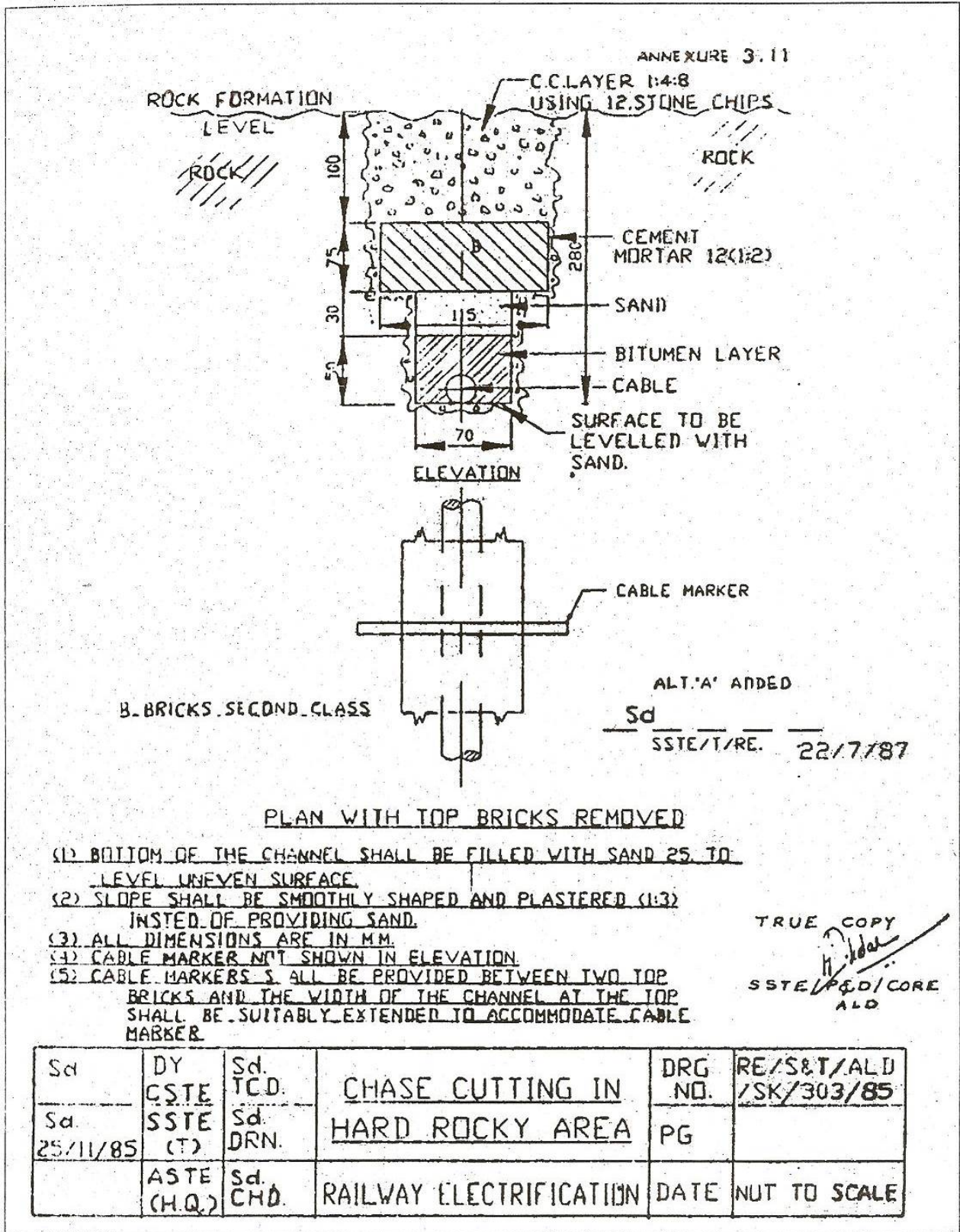

ANNEXURE 2-14

RAIL TEL CORPORATION OF INDIA LTD.

RCC CIRCULAR JOINT ENCLOSURE

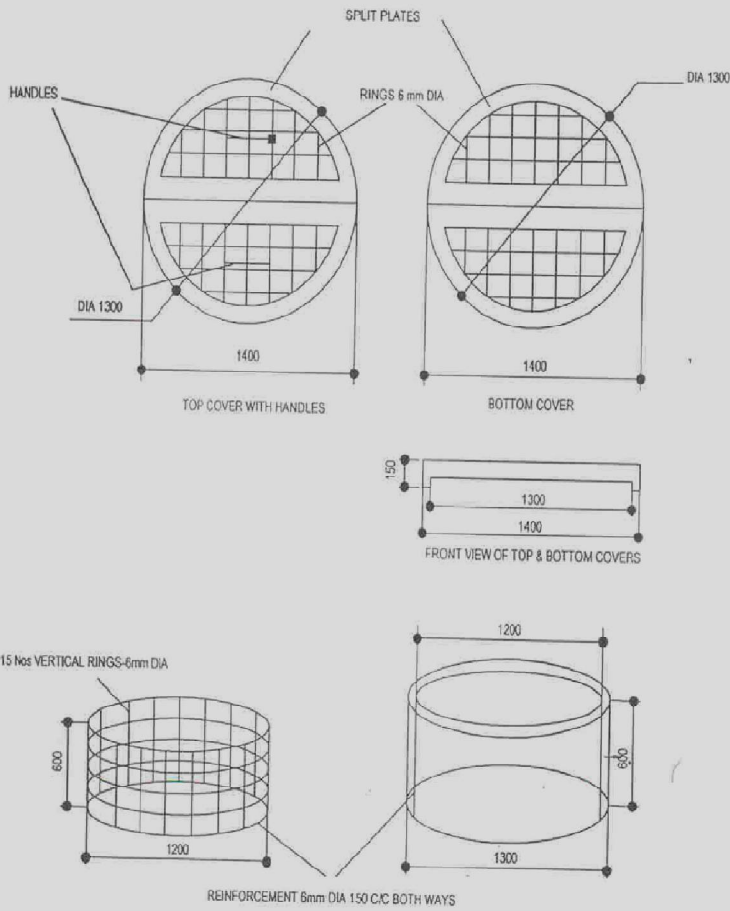

DRG.NO. RCIL/N.REGION/03/2004

RailTel Corporation of India Limited

R.C.C Cable Route Marker (Stone)

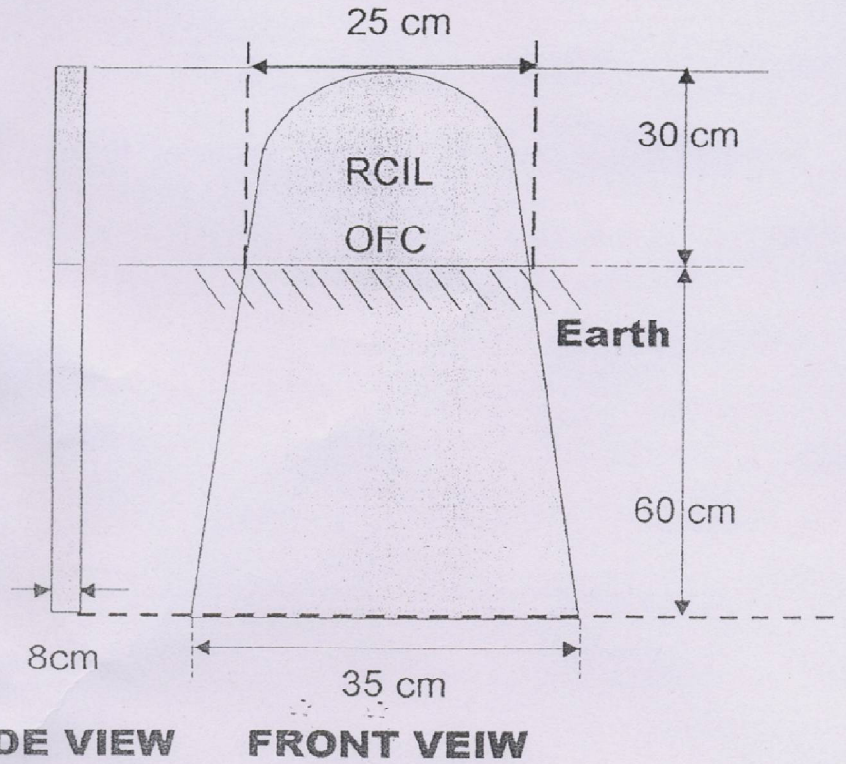

Not To Scale

1. All Sides above ground to be Painted with Red enameled Paint to IS specification with Two Coats.
2. All Sides above ground to be Painted with Green enameled Paint to IS specification with 2 Coats at OFC Joints .
3. RCIL OFC to be engraved.
4. Engraved portion to be Painted with White Enameled Paint to IS specification with 2 Coats.

Drg No. RCIL/N Region/01/2004

Maintenance Free Earthing

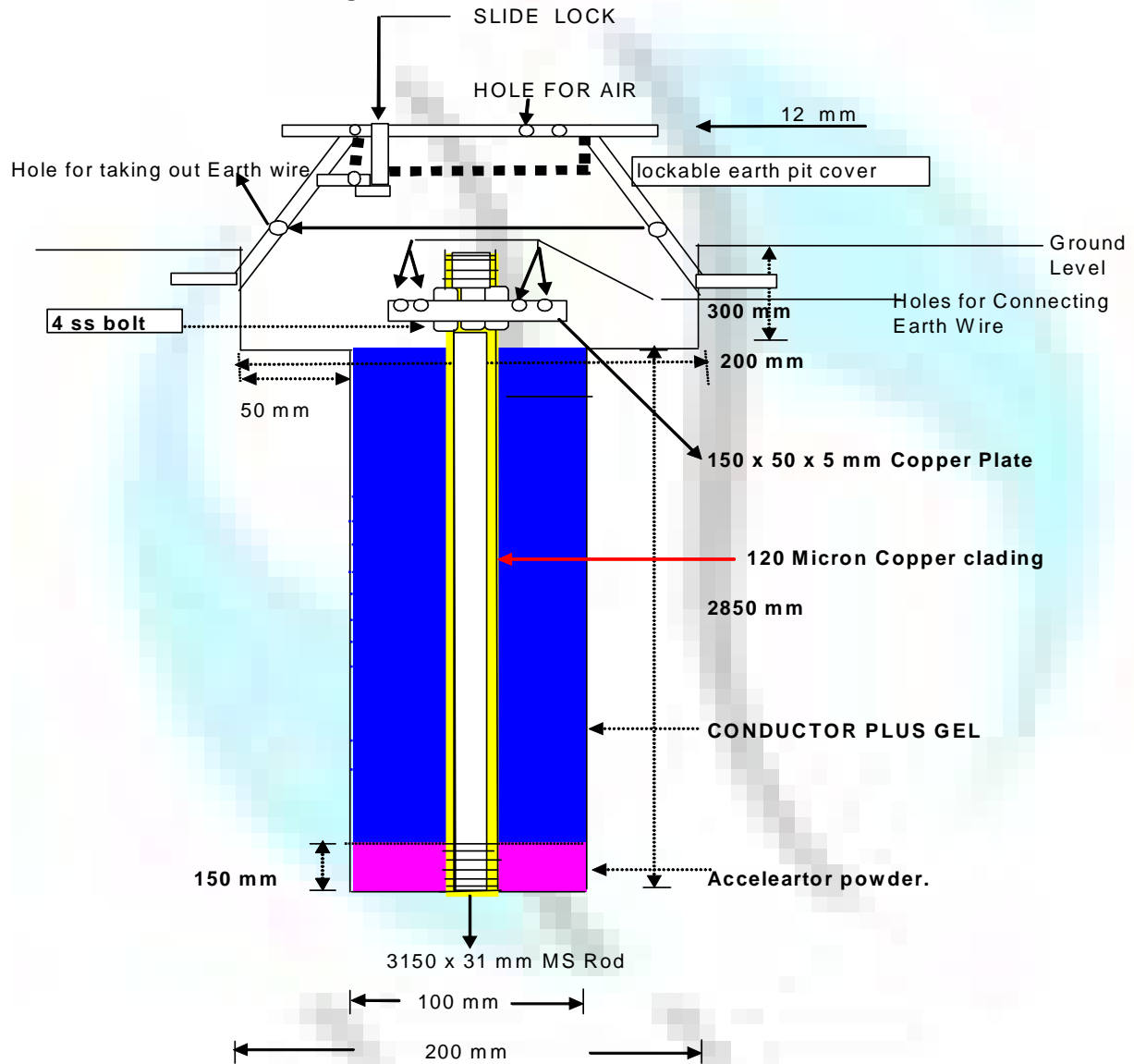

RAILTEL

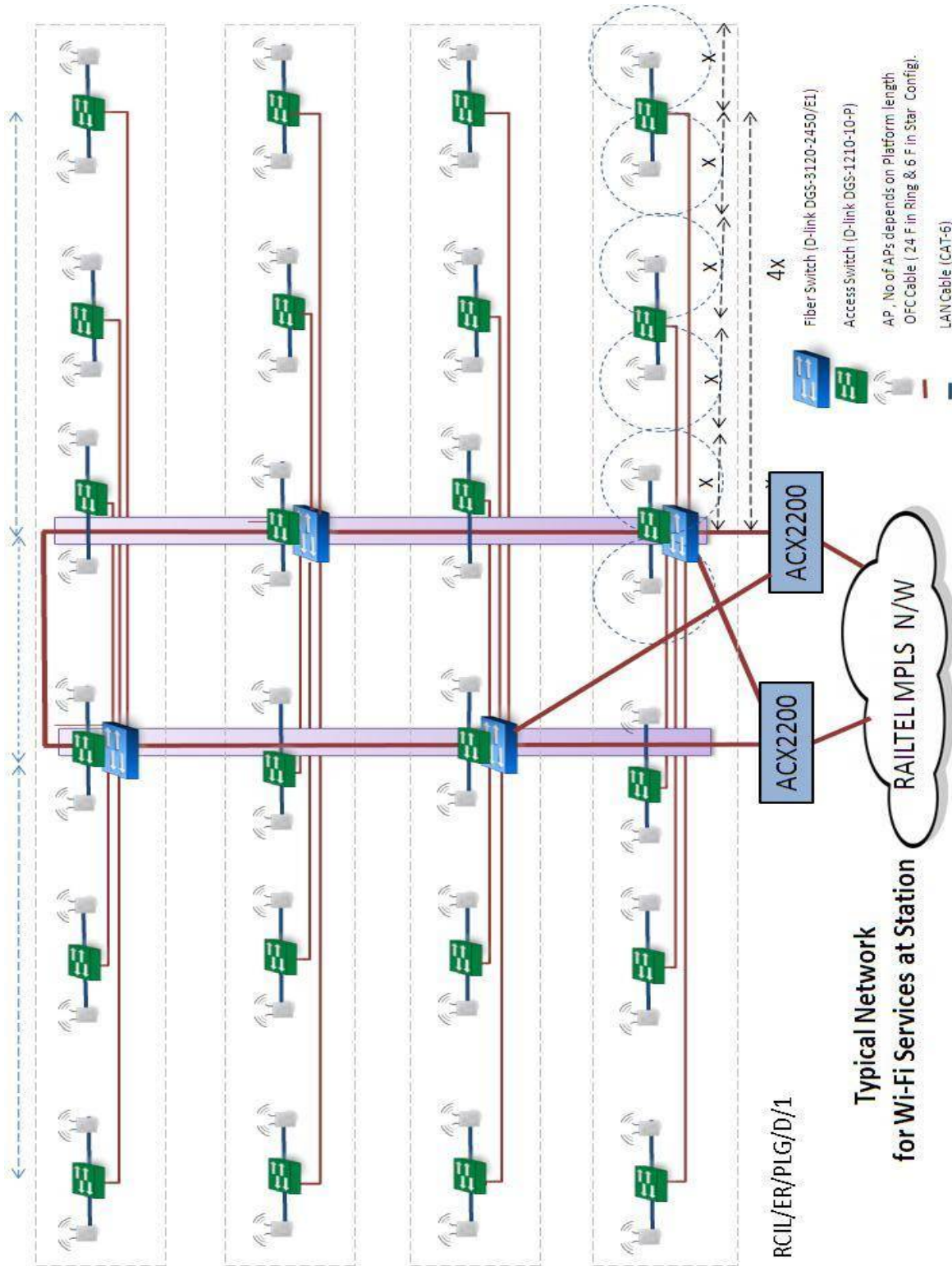

RCIL/ER/PLG/D/1

**Typical Network
for Wi-Fi Services at Station**

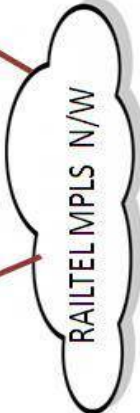

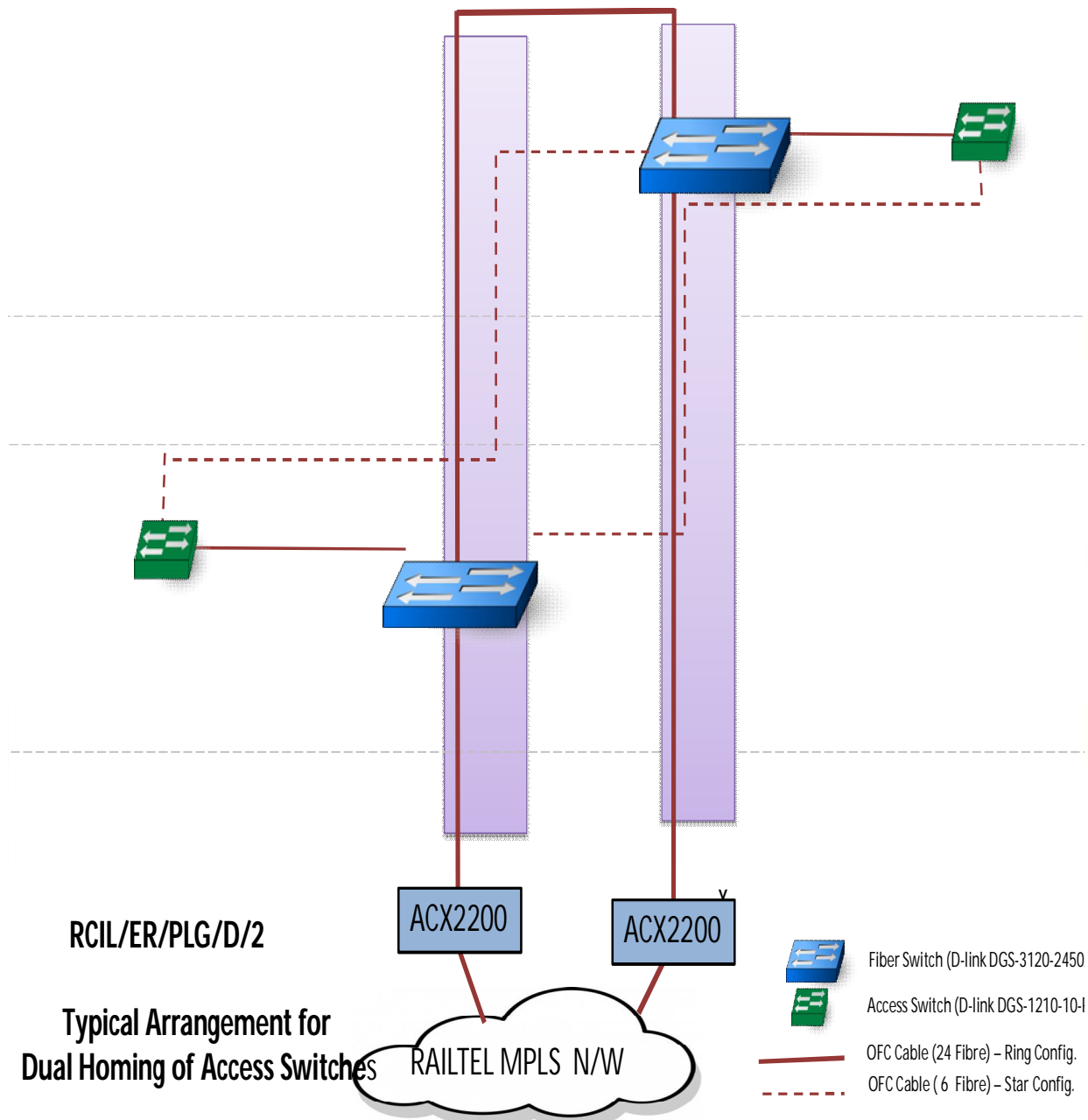

LIST OF STATIONS	
SN	RAILWAY STATION
1	Ambala Cantt
2	Amritsar
3	Bareilly
4	Chandigarh
5	Haridwar
6	Jalandhar City
7	Jammu Tawi
8	Ludhiana
9	Moradabad
10	Dehradun

राज्य
RAILTEL

